

# **ERROR DISTRIBUTIONS AND ACCURACY MEASURES IN NAVIGATION: AN OVERVIEW**

**STELIOS P. MERTIKAS**

**February 1985**



**TECHNICAL REPORT  
NO. 113**

## PREFACE

In order to make our extensive series of technical reports more readily available, we have scanned the old master copies and produced electronic versions in Portable Document Format. The quality of the images varies depending on the quality of the originals. The images have not been converted to searchable text.

# **ERROR DISTRIBUTIONS AND ACCURACY MEASURES IN NAVIGATION: AN OVERVIEW**

Stelios P. Mertikas

Department of Surveying Engineering  
University of New Brunswick  
P.O. Box 4400  
Fredericton, N.B.  
Canada  
E3B 5A3

February 1, 1985  
Latest Reprinting February 1994

## ABSTRACT

The present report contains a description of some statistical terms associated with the accuracy of a position fix in navigation. It summarizes the principal results of a series of statistical studies related to error distributions and accuracy measures in navigation.

The material breaks up into four main parts. The first part provides an introduction to the problems associated with and the need for statistical data analysis in navigation. The second section is devoted to error distributions. The distributions considered include the Normal, the Exponential, the two-parameter Gamma, the Double Exponential, the Compound and Composite distributions, the Rayleigh etc. Sections 2.1 to 2.9 introduce a few definitions of probability density functions, while the last section presents the applications of these distributions to navigational problems. The third part brings in an exposition of the various accuracy measures which characterize uncertainty in navigation. These measures include the ellipsoids, the ellipses, the radial errors and some of the one-dimensional accuracy measures. Finally, the report concludes with some suggestions for the future.

The purpose of this presentation is to collect, under one cover, most of the essential aspects of the available literature devoted to error distributions and accuracy measures in navigation.

## TABLE OF CONTENTS

	<u>Page</u>
Abstract . . . . .	ii
Table of Contents . . . . .	iii
List of Figures . . . . .	iv
List of Tables . . . . .	v
Acknowledgements . . . . .	vi
1. INTRODUCTION . . . . .	1
2. ERROR DISTRIBUTIONS IN NAVIGATION . . . . .	4
2.1 Rectangular (or Uniform) Distribution . . . . .	5
2.2 Normal (Gaussian Distribution . . . . .	5
2.3 Student's t Distribution . . . . .	9
2.4 The Two-Parameter Gamma Distribution . . . . .	10
2.5 The Double Exponential Distribution (or Gumbel) . . . . .	10
2.6 Rayleigh Distribution . . . . .	12
2.7 Compound Distributions . . . . .	13
2.8 Composite Distributions . . . . .	17
2.9 Sinusoid Distribution . . . . .	19
2.10 Distribution Used in Navigational Practice . . . . .	19
2.10.1 Normal . . . . .	19
2.10.2 Exponential . . . . .	21
2.10.3 Two-Parameter Models . . . . .	22
2.10.4 Compound Distributions . . . . .	23
2.10.5 Double Exponential . . . . .	23
2.10.6 Double Double Exponential . . . . .	24
2.10.7 Rayleigh . . . . .	24
2.10.8 Sinusoid . . . . .	26
2.10.9 Other Distribution Models . . . . .	26
2.11 What to do in Practice . . . . .	27
3. ACCURACY MEASURES . . . . .	29
3.1 Hyperellipsoids, Ellipsoids and Ellipses . . . . .	29
3.2 Radial Errors . . . . .	46
3.2.1 Radial Probable Error . . . . .	50
3.2.2 Circular and Spherical Probable Errors . . . . .	51
3.2.3 Geometrical Mean Error . . . . .	58
3.2.4 Circles Including a Specified Probability . . . . .	60
3.2.5 The drms Error . . . . .	62
3.3 One-Dimensional Accuracy Measures . . . . .	64
3.3.1 The Standard Deviation . . . . .	64
3.3.2 The Root-Sum-Square Error . . . . .	65
3.3.3 The Root-Mean-Square Error . . . . .	65
3.3.4 The Geometric Dilution of Precision . . . . .	66
4. CONCLUSIONS AND FUTURE TRENDS . . . . .	67
REFERENCES . . . . .	71

## LIST OF FIGURES

	<u>Page</u>
2.1 The rectangular and normal distributions . . . . .	6
2.2 The student and gamma distributions. . . . .	11
2.3 The Rayleigh distribution . . . . .	11
2.4 The probability of the standard deviation $h^*(\sigma)$ for $\lambda=1$	16
2.5 Construction of the standard deviation distribution derived by Burgerhout (1973) . . . . .	16
2.6 Truncation and censoring . . . . .	18
2.7 The normex distribution . . . . .	18
2.8 The sinusoid distribution . . . . .	18
2.9 Observed position-error distribution and fitted distribution curves using 7852 observations of aircraft lateral deviations . . . . .	25
3.1 The bivariate normal density function . . . . .	31
3.2 Ellipsoid of constant probability ( $u=3$ ) . . . . .	36
3.3 Confidence ellipse ( $u=2$ ) . . . . .	41
3.4 Confidence ellipse with unequal eigenvalues . . . . .	43
3.5 Confidence ellipse with equal eigenvalues . . . . .	43
3.6 Radial error in the three-dimensional case . . . . .	47
3.7 Geometrical depiction of the CPE circle . . . . .	53
3.8 Relationship of the CPE circle and the equivalent error ellipse . . . . .	53
3.9 Determination of CPE and SPE using a standard normal . . . . .	55
3.10 Results of numerical integration . . . . .	55
3.11 Exact and approximate forms of CPE . . . . .	57
3.12 The definition of the geometrical mean error (GME) . . . . .	59
3.13 The drms radial error . . . . .	63
4.1 The geometry of a random field . . . . .	69

LIST OF TABLES

	<u>Page</u>
1. Probability of Various Error Ellipsoids . . . . .	44
2. Probability of Various Error Ellipses . . . . .	44
3. Relationship of CPE and Radii of Other Probability Circles.	61
4. Normal Distribution of Errors . . . . .	64

## ACKNOWLEDGMENTS

I have the pleasant duty of recording my indebtedness to Professor Roman Mureika and Mr. Antonis Armenakis of the Department of Mathematics and Statistics, to Mr. Hal Janes and to Miss Lynda Ellis who read the whole manuscript with the greatest care and removed many blemishes.

Further, I am indebted to Professor Dave E. Wells, Professor Richard Langley and Dr. Alferd kleusberg, members of my supervisory committee, who drew my attention to a number of points requiring revision. Special thanks are also due to Mr. Demitris Paradissis of the National Technical University of Athens, and Professor P.A. Parker from the Electrical Engineering Dept. of U.N.B., who gave so willingly and meticulously care in the reading of the manuscript.

The help of Mr. John F. Roeber at the U.S. Merchant Marine Academy, Dr. E.M. Goodwin at the Department of Mathematics Statistics and Computing of the North London Polytechnic, Mr. O.D. Anderson and Dr. D.A. Hsu of the Statistics Department at the University of Wisconsin in providing information concerning navigation is also acknowledged.

This work was supported by the Natural Sciences and Engineering Research Council of Canada.



## 1. INTRODUCTION

The determination of a position fix always raises the questions of how much data of a given accuracy will be required, what computational approach should be used and how much reliance may be placed upon the results. As any process that involves measurement can not be made without error, uncertainty of navigation fix is normally expressed in terms of quantities which are subject to probabilistic fluctuations. Therefore, practically useful answers to the above problems may be found by the theory of statistical estimation.

Determination of coordinates of a remote point (e.g., the craft) with respect to a known or arbitrary reference system is referred to as point estimation as opposed to the interval estimation concerning the accuracy of the position fix. The major concern of this paper would be the second aspect of interval estimation of navigation fixes. It should be also noted that here the term navigation implies a chronological sequence of position fixes.

Nowadays, a large class of navigators is no longer interested in a level of accuracy that would lead them generally close to their destination because of its economic importance, but in preventing groundings of very large ships (e.g., supertankers) in narrow and congested channels or in avoiding a miss of the runway or a collision with another

craft due to low visibility. The requirement for more accurate navigation has increased and it has got sharp and critical bounds. The craft must be conducted within certain limits. It does not matter if the ship is not exactly in the center of the channel or if the airplane does not land quite dead-centered on the runway, but it does when they both exceed certain limits.

On the other hand, there is another quite large number of users for which interval estimation (the uncertainty of their position fix) plays an important role to their strict accuracy requirements. Positioning for oil exploration, drilling, pipe laying, ocean mining, 3D-seismic surveys, preparation of charts, positioning aids to navigation, landing and take off operations etc. are some examples of activities that require precise navigation. Though, less stringent accuracy requirements are those related to commercial and sport fishing, to the enforcement of national resource boundaries (law of the sea), and to offshore and continental navigation.

Trying to express accuracy in navigation systems gave rise to the analysis of error distributions in navigation. As we shall see later, extensive efforts have been directed towards this vein in an attempt to solve the problem of collision avoidance and to establish safety separation standards (Abbot,1965; Burgerhout,1973; Hsu,1981,1983; Lord and

Overton,1971; Lord,1973; Rabone,1971; Reich,1966). However, these analyses and consequently the accuracy measures derived from them, have been formulated in a static way, that is, they do not depend on time and space . This is so because an assessment of the accuracy of a position fix faces a lot of problems in navigation. The lack of comparison of position fixes with fixed survey monuments, the difficulty in repeating an observation because of craft movement, the marking of a position at sea or in the air space are the major problems in navigation that one usually encounters.

The importance of investigating navigation errors lies in the following points:

1. The better understanding of the errors and limitations of the measurements performed.
2. The careful planning of navigation accuracy standards.
3. The standardization of navigation accuracy measures and assurance of uniform publication of statistics (i.e., communication of information).
4. The monitoring of existing and future navigation systems for their compliance with established specifications (e.g., those proposed by Air Traffic Control(ATC), International Maritime Organization(IMO), International Civil Aviation Organization(ICAO), etc.)

5. The need to specify the proportion of position errors which are in excess of a threshold (critical) value so as to ensure safety.
6. The establishment of formal procedures for the evaluation, testing and design of navigation systems.
7. The need for simplified algorithms describing accuracy measures for practical use.

## 2. ERROR DISTRIBUTIONS IN NAVIGATION

To express accuracy of observations, we have to make some assumptions about the pattern of the distribution of errors in the form of a single compact mathematical model, that is the law of errors or the distribution function of errors. This is so because there is a direct relationship between the order of magnitude of the error and the frequency (distribution) with which an error of this order occurs in a large collection of results. Moreover, a discussion on the error distributions in navigation will follow.

At this stage, an introduction to a few definitions of probability density functions seems necessary as a means of clarifying the discussion to follow.

## 2.1 RECTANGULAR (OR UNIFORM) DISTRIBUTION

A continuous random variable  $X$  (e.g., the value of position error in one-dimension) will be said to have a uniform distribution, if its density probability function is given by:

$$f(x; a, b) = \begin{cases} \frac{1}{b-a} & \text{for } a \leq x \leq b \\ =0 & \text{elsewhere.} \end{cases} \quad (2.1)$$

The frequency curve consists of a rectangle on the range  $(a, b)$  as base and of height  $\frac{1}{b-a}$ . In this distribution all values of the variate  $X$  from  $a$  to  $b$  are equally frequent (likely to happen).

Properties. The mean is  $m = \frac{b+a}{2}$  and the variance  $\frac{(b-a)^2}{12}$ .

## 2.2 NORMAL (GAUSSIAN) DISTRIBUTION.

A random variable  $X$  is said to be normally distributed and denoted as  $N(m, \sigma^2)$ , if its probability density function is of the form:

$$f(x; m, \sigma^2) = \frac{1}{\sqrt{2\pi}\sigma} \exp\left\{-\frac{(x-m)^2}{2\sigma^2}\right\} \quad (2.2)$$

where

-  $\sigma$  is the standard deviation

-  $m$  is the mean value.

The parameter  $h = \frac{1}{\sigma\sqrt{2}}$  is sometimes called the precision modulus.

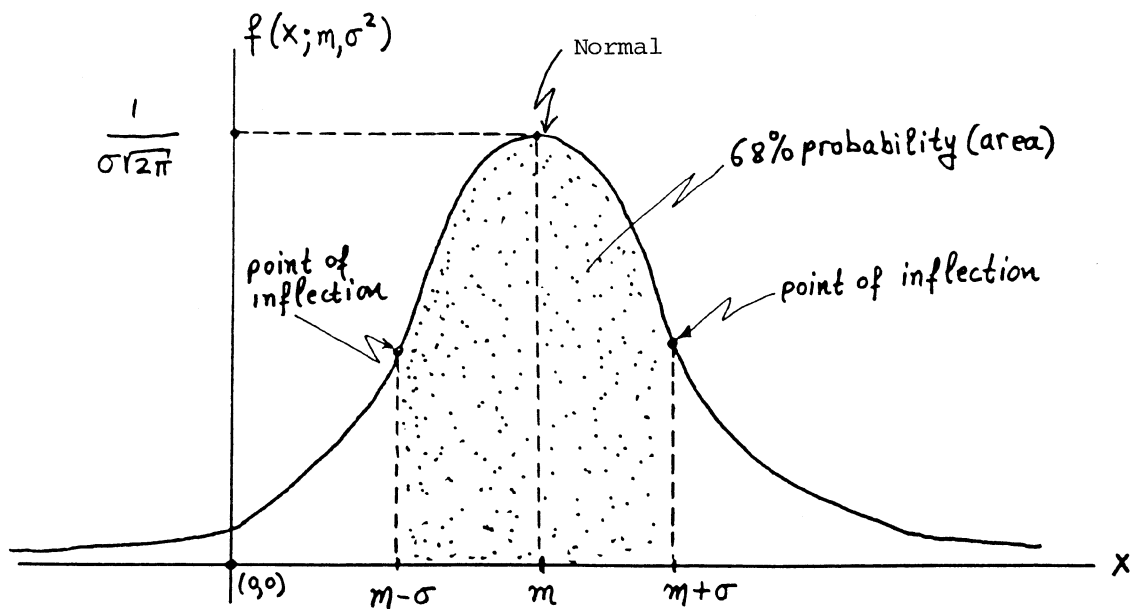
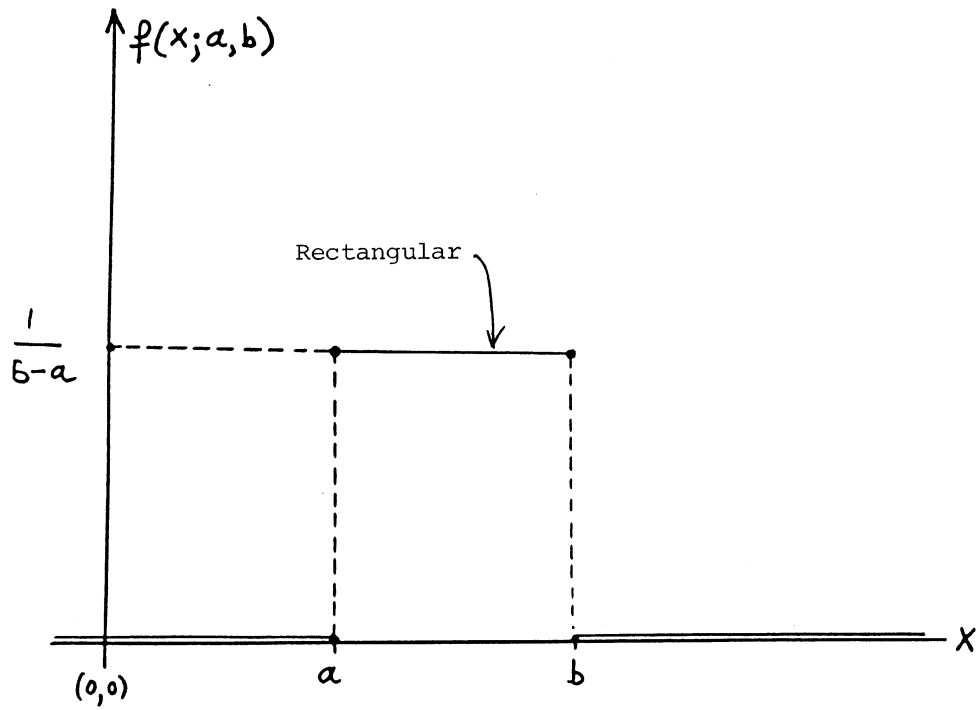

Figure 2.1: The Rectangular and Normal Distributions.

The Normal distribution has a unique position in probability theory. For many decades, it held a central position in statistics and it became widely and uncritically accepted as the basis of much practical work. This is because, it was found (Johnson and Kotz,1970) that error distributions followed the Normal law more or less closely. The curve was the ideal to which most distributions should in some degree attain, and that an explanation was demanded if they did not.

Most arguments for the use of the Normal distribution are based on the following reasons:

1. Intuition and Tradition. Empirical distributions of actual errors were found by Gauss and Laplace to be well approximated by the Normal distribution. It seemed reasonable that errors in observation should be as likely to be positive as to be negative and should become less and less frequent as they increased in absolute magnitude. And, in fact, the empirical error distributions appeared to be unimodal and symmetrical about the "true" value, on either side of which they seemed to decrease monotonically.
2. Simplicity of the distribution. This is one of the basic mathematical properties of the Normal distribution that makes it attractive. All moments and cumulants (Kendall and Buckland,1982) derived from the Normal distribution are expressible in very simple forms and are easy to manipulate.

3. Conformity to the Central Limit Theorem. This theorem gives the Normal distribution its central place in the theory of probability and in the theory of sampling. The theorem asserts that "the sum of a large number of independent random variables will be approximately Normally distributed almost regardless of their individual distributions". Therefore, any random variable which can be regarded as the sum of a large number of small, independent contributions is likely to follow the Normal law. Presumably, many factors contribute to an error of observation: variations in weather conditions, human error, facility-imprecision etc. If each such cause contributes an "elementary error" which is relatively small and independent of all others, then as the number of elementary errors approaches infinity, the distribution of errors in observation approaches the Normal distribution.
4. Use as an approximation. We should emphasize that the Normal distribution is almost always used as an approximation. The chaos of unpredictable elementary errors seems easier to handle, if we assume the Normal distribution as the error law. Additionally, a known but complicated distribution can be replaced by a Normal distribution (e.g., a simple mathematical function) which supplies almost the same characteris-



tics, for example having the same mean and standard deviation (Feller,1968).

Another area of application is in statistical testing. Often not as much of the practical value of statistical tests, as because of the elegance of calculation (avoidance of formidable mathematics) mathematicians and mathematical statisticians developed statistical tests presupposing a Normally distributed population. Therefore, today almost all the tests and statistics (e.g.,Feller,Pearson,Student etc.) are based on the assumption of validity of Normal distribution.

### 2.3 STUDENT'S I DISTRIBUTION.

This distribution, originally due to 'Student' is given by:

$$f(t;v) = \frac{\Gamma(\frac{v+1}{2})}{\Gamma(\frac{v}{2})\sqrt{\pi \cdot v}} \left\{1 + \frac{t^2}{v}\right\}^{-\frac{v+1}{2}} \quad (2.3)$$

where  $v$  is called the degrees of freedom. The name "Student" comes from the pseudonym of its discoverer W.S. Gosset. The gamma function  $\Gamma(\cdot)$  is defined as:

$$\Gamma(x) = \int_0^{\infty} t^{x-1} e^{-t} dt \text{ for all } t > 0 \quad (2.4)$$

It interpolates the factorials in the sense that

$$\Gamma(n+1) = n! \quad \text{for } n=0,1,2,3,\dots \quad (2.5)$$

where  $n$  is natural number and  $0! = 1$ .

Integration shows that

$$\Gamma(t) = (t-1) \Gamma(t-1) \quad , \text{ for all } t > 0 \quad (2.6)$$

It can be seen that the distribution depends on the degrees of freedom and is unimodal and symmetrical about the origin ( $t=0$ ), and extends to infinity in both directions.

Properties: The mean is zero and the standard deviation is  $\frac{v}{v-1}$  ( $v \geq 1$ ). It is noteworthy that the distribution has no variance when  $v < 1$ .

#### 2.4 THE TWO-PARAMETER GAMMA DISTRIBUTION.

A random variable  $X$  that has a probability density function:

$$g(x; \alpha, \beta) = \begin{cases} \frac{1}{\beta^2 \Gamma(\alpha)} x^{\alpha-1} e^{-x/\beta} & 0 < x < \infty \\ 0 & \text{elsewhere} \end{cases} \quad (2.7)$$

is said to have a gamma distribution with parameters  $\alpha$  and  $\beta$ . The special case for which  $\alpha = 1$  represents the exponential density function.

Properties: The mean and variance of  $X$  are  $\alpha\beta$  and  $\alpha\beta^2$  respectively.

#### 2.5 THE DOUBLE EXPONENTIAL DISTRIBUTION (OR GUMBEL).

If  $\lambda$  and  $\theta$  are constants, then a random variable  $X$  is said to have a Double Exponential Distribution (two-sided exponential), when its frequency is given by:

$$f(x; \lambda, \theta) = \frac{1}{2\lambda} \exp\left(-\frac{|x-\theta|}{\lambda}\right), \quad \lambda > 0. \quad (2.8)$$

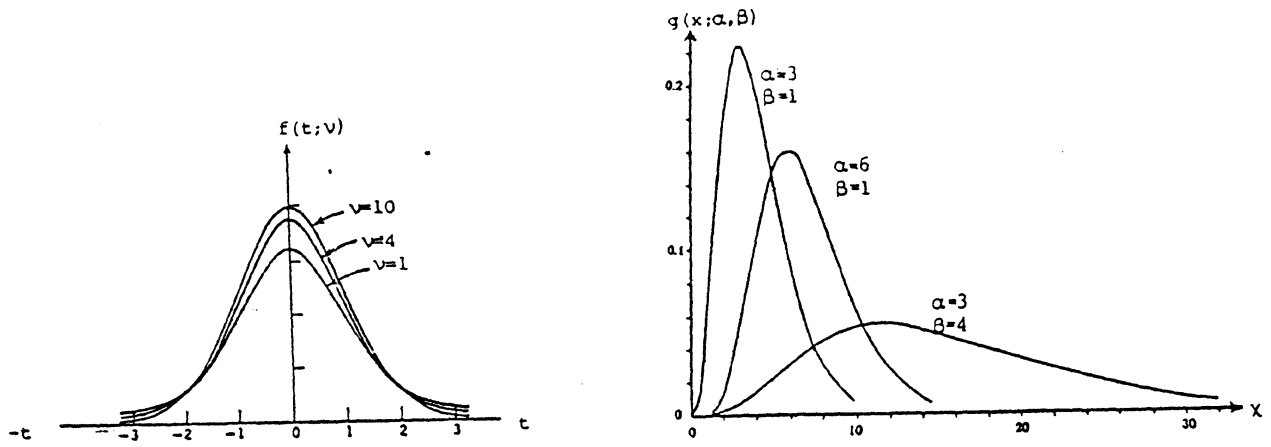

Figure 2.2: The Student and Gamma distributions.

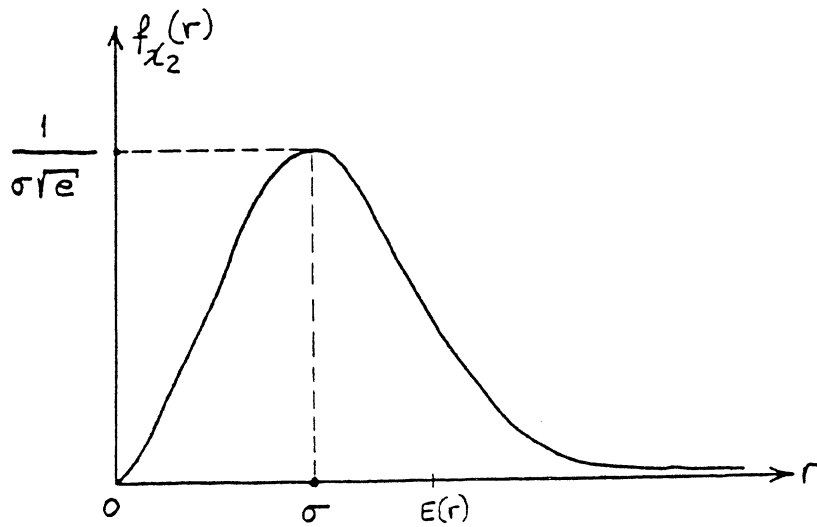

Figure 2.3: The Rayleigh distribution.

This distribution is also known as the first Laplacian Law of Errors in contradiction to the Normal distribution known as the second Laplacian Law of Errors. It should be noted that if the variance of a Normal variate is distributed in accordance with an exponential distribution, then the resulting compound distribution (see section 7) is the Double Exponential (Hsu,1979a).

Properties: The mean value of  $X$  is  $\theta$  and the variance  $2\lambda^{-2}$ .

## 2.6 RAYLEIGH DISTRIBUTION.

Consider the square root of the sum of the squares of  $v$  variates each Normally distributed with zero mean and standard deviation  $\sigma$ , that is:

$$r = \sqrt{x_1^2 + x_2^2 + \dots + x_v^2}, \quad (2.9)$$

where  $x_i$  ( $i=1, v$ ) is Normally distributed with  $N(0, \sigma^2)$ . In other words, consider the square root of a chi-square distribution with  $v$  degrees of freedom. This probability density function is given (Johnson and Kotz,1970) as:

$$f_{\chi_v}(r) = \left[2^{\frac{v}{2}-1} \Gamma\left(\frac{v}{2}\right)\right]^{-1} r^{v-1} \exp\left(-\frac{r^2}{2}\right), \quad r \geq 0. \quad (2.10)$$

In the case where  $v=2$ , this distribution of the radial errors is sometimes called the Rayleigh distribution (also called the Circular Normal Distribution) with probability function:

$$f_{\chi_2}(r) = r \cdot \exp\left(-\frac{r^2}{2}\right); \quad r = \sqrt{x_1^2 + x_2^2} \geq 0 \quad (2.11)$$

Therefore, if the rectangular deviations  $X_1$  and  $X_2$  of a shot from the center of a target are independent and Normal with  $N(0, \sigma^2)$ , the distance  $r = \sqrt{x_1^2 + x_2^2}$  from the center will have a Rayleigh distribution.

Properties. The mean value is  $E(r) = \sqrt{\frac{\pi}{2}} \sigma$  and the variance  $(2 - \frac{\pi}{2}) \sigma^2$ , where  $\sigma^2$  is the variance of the two independent Normal random variables  $x_1$  and  $x_2$ .

It should be also mentioned that the square root of a chi square distribution with three degrees of freedom constitutes another important special case which is called Maxwell distribution.

## 2.7 COMPOUND DISTRIBUTIONS.

Let a probability density function of a continuous random variable  $X$ ,  $f(x; \theta)$ , depend on a parameter  $\theta$ , which also has a frequency distribution  $h(\theta)$ . The distribution obtained by summing over the parameter  $\theta$  is said to be compound (Kendall and Buckland, 1982). In mathematical terms that means:

$$p(x; \theta) = \int_{\theta} f(x; \theta) h(\theta) \cdot d\theta \quad (2.12)$$

For example, consider that an observed position error  $X$  is a random variable having a Normal distribution  $f(x; 0, \sigma^2)$  (mean value is zero), while the corresponding variance  $(\sigma^2)$  follows an Exponential distribution of the form (Hsu, 1979b):

$$h(\sigma^2) = \frac{1}{2\lambda^2} \exp\left(-\frac{\sigma^2}{2\lambda^2}\right), \quad 0 < \sigma^2 < \infty, \quad \lambda > 0 \quad (2.13)$$

Then, the resultant compound distribution would be:

$$\begin{aligned}
 p(x; \sigma^2) &= \int_0^\infty f(x; 0, \sigma^2) h(\sigma^2) d\sigma^2 = \\
 &= \frac{1}{2\lambda^2 \sqrt{2\pi}} \int_0^\infty \frac{1}{\sigma} \exp\left[-\left(\frac{x^2}{2\sigma^2} + \frac{\sigma^2}{2\lambda^2}\right)\right] d\sigma^2 \quad (2.14)
 \end{aligned}$$

An illustration of the distribution of the standard deviation  $h^*(\sigma)$ , ( $h^*(\sigma) = 2\sigma \cdot h(\sigma^2)$ ), is given in Figure (2.4).

It has been proved by Hsu(1979b), that this compound distribution is nothing else but a Double Exponential with zero mean, that is:

$$p(x; \sigma^2) = f(x; \lambda, 0) = \frac{1}{2\lambda} \exp\left\{-\frac{|x|}{\lambda}\right\}, \lambda > 0 \quad (2.15)$$

Another example of a complicated model for the standard deviation is suggested by Burgerhout(1973). This distribution is shown in Figure 2.5 and is derived from a Normal distribution with mean  $m_\sigma$  and standard deviation  $\sigma_\sigma$  by adding the left shaded part of the left quadrant to the right quadrant. This compound distribution deduced from the above assumptions will be given as:

$$\boxed{p(x; m_\sigma, \sigma_\sigma) = \int_0^\infty f(x; 0) h(\sigma; m_\sigma, \sigma_\sigma) d\sigma} \quad (2.16)$$

The mean and standard deviation of  $X$  which underlies  $p(x; m_\sigma, \sigma_\sigma)$  are summarized in Burgerhout(1973) as follows:

$$\mu = \text{mean} = 0, \text{ standard deviation} = \sqrt{m_\sigma^2 + \sigma_\sigma^2}$$

Finally, if the function  $h(\theta)$  is a step function with steps at  $\theta_1, \theta_2, \dots, \theta_k$ , then the eq.(2.12) reduces to:

$$P_m(x) = \epsilon_1 f_1(x; \theta_1) + \dots + \epsilon_k f_k(x; \theta_k) = \sum_{i=1}^k \epsilon_i f_i(x; \theta_i) \quad (2.17)$$

where the coefficients  $\epsilon_i$  are mixing proportions ( $\epsilon_i > 0$ ) assigned to every function  $f_i(x; \theta_i)$  that sum up to one:

$$\sum_{i=1}^k \epsilon_i = 1 \quad (2.18)$$

This process of obtaining a discrete weighted average of a group of distribution functions is sometimes termed (Johnson and Kotz, 1970) mixture of distributions. To simulate the effect of mild outliers in an experiment, we can try to approximate the error distribution by a mixture of two distributions. The first one will describe the "ordinary" data without clear outliers, while the other will indicate the contamination due to outliers. This idea of contamination was originally considered by Tukey (1960). It can be implemented by assigning a fraction  $\epsilon$  of contamination of the same error distribution but with larger standard deviation.

For example, if  $f(t; \nu_1, s_1)$  and  $f(t; \nu_1, s_1)$  are two Student's  $t$  distributions, then:

$$P_m(t) = (1-\epsilon)f(t; \nu_1, s_1) + \epsilon f(t; \nu_2, s_2) \quad (s_1 < s_2) \quad (2.19)$$

represents a mixture of two Student's distributions called the Double  $t$  distribution. A mixture of two Double Exponentials is defined as the Double Double Exponential distribu-

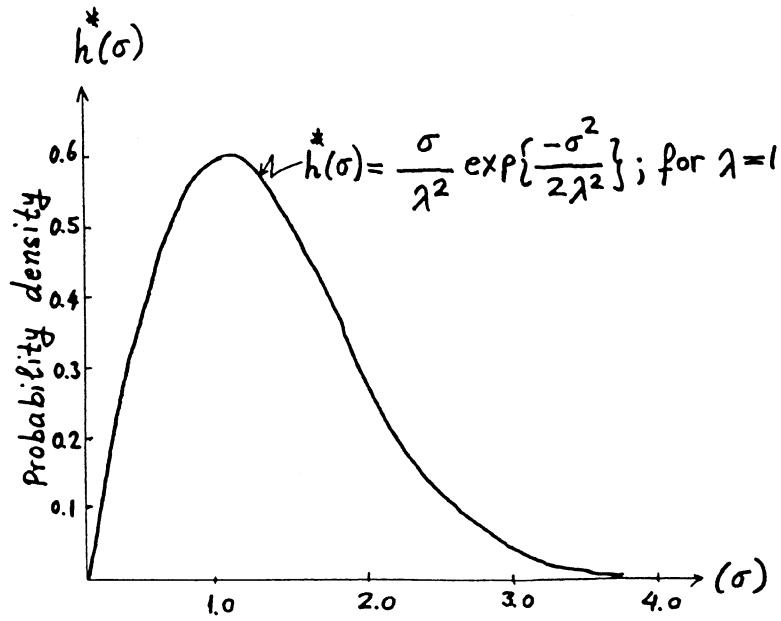

Figure 2.4: The Probability of the Standard Deviation  $h^*(\sigma)$  for  $\lambda=1$  (after Hsu,1979b).

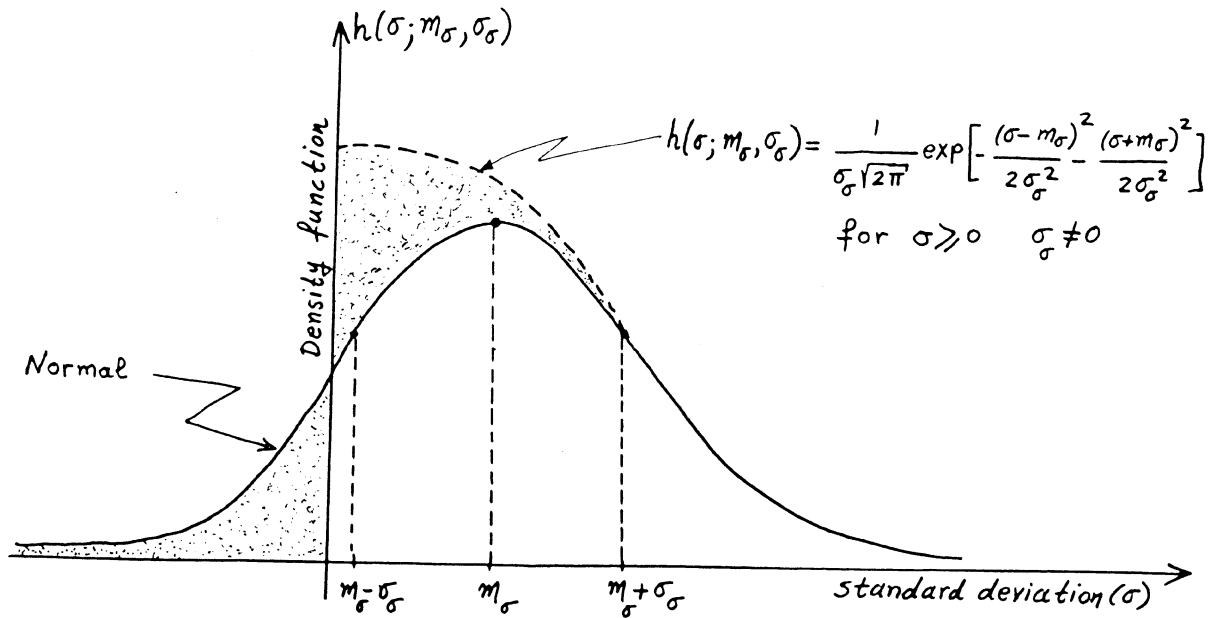

Figure 2.5: Construction of the Standard Deviation Distribution Derived by Burgerhout(1973).



tion. More details on the mixtures of distribution can be found in Hsu(1979,a,b) and Hsu(1980).

## 2.8 COMPOSITE DISTRIBUTIONS.

This sort of conception is sometimes useful in fitting curves to observed data. A density distribution function (e.g., Normal) may fit the data quite well in a certain range of a variate, while another type of distribution may fit to the remainder region. There are two notions involved in the above concept: censoring and truncation (Johnson and Kotz,1970; Kendall and Buckland,1982). In some cases, the number of observations greater than a fixed value (for example  $x_0$ ) may be known but practical considerations impose the use of only values of  $x$  less than  $x_0$ . This kind of agreement to ignore observed values is called censoring, whereas the omission of values greater than the fixed value  $x_0$ , because of measuring limitations of the instruments, is termed truncation. A kind of composite distribution is the Normex Distribution (Rabone,1971; Lord,1973). This is a combination of the Normal and the Exponential. The Normal distribution describes the central part of data (e.g., near the mean) while the tails are represented by an exponential function. (see Figure 2.7).

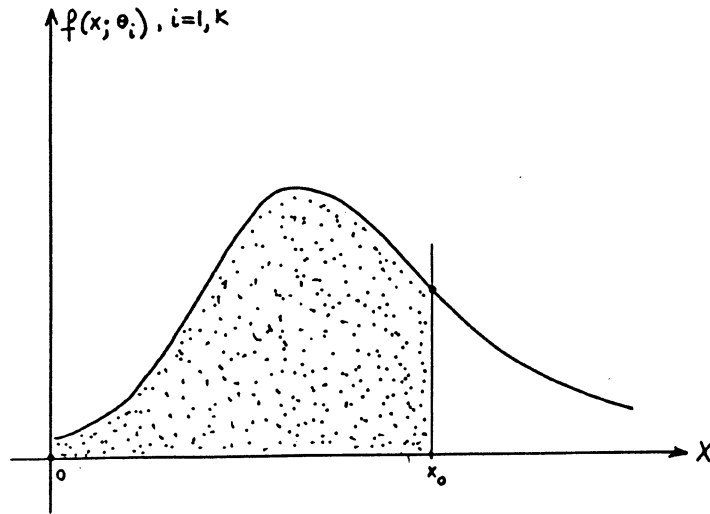

Figure 2.6 : Truncation and Censoring

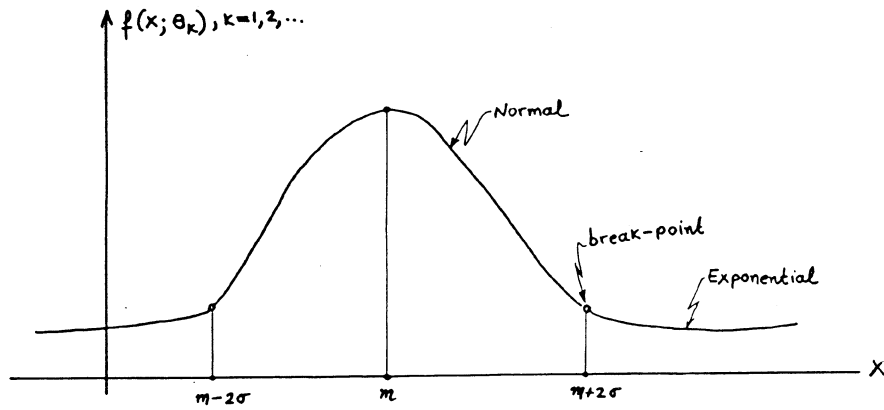

Figure 2.7: The Normex Distribution

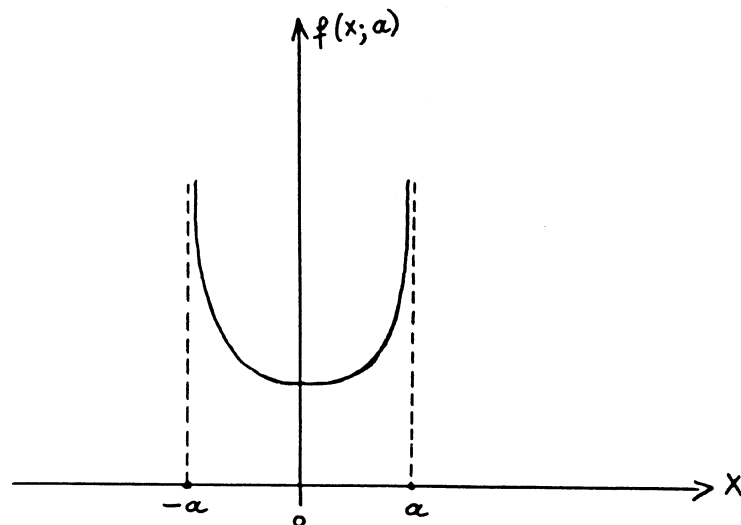

Figure 2.8: The Sinusoid Distribution

## 2.9 SINUSOID DISTRIBUTION.

This distribution has a U-shaped hollow density probability function and it is defined as (Bendat and Piersol, 1971):

$$f(x;a) = \left. \begin{array}{l} \frac{1}{\pi\sqrt{a^2-x^2}} \quad \text{for } |x| < a \\ = 0 \quad \text{for } |x| > a \end{array} \right\} \quad (2.20)$$

It arises when a reading from a (navigation) system oscillates about a mean value.

Other models for error distributions applied to position errors in navigation have been suggested by Marchand (1964) and Hiraiwa (1978).

## 2.10 DISTRIBUTION USED IN NAVIGATIONAL PRACTICE

### 2.10.1 Normal

From our discussion on the Normal distribution, it seems likely that position errors in navigation would not depart from the general rule (i.e., the Normal law). Historically, however, position errors in navigation appear to follow a rather different course.

Navigational errors of careful observations made under uniform circumstances might be well described by a Normal distribution (Anderson and Ellis, 1971; Parker, 1972). With the additional complications of non uniform conditions, such

as different weather, varying navigational procedures and skills, different sets of instruments and geometrical configuration, one should expect longer-tailed distributions (Anderson,1965; Abbott,1965; Hsu,1979a,b,1980; Parker,1972,1981).

It was found at an earlier date that error distributions in navigation can not be described accurately by the Normal distribution (Anderson,1965). Later, as several thousands of data were accumulated (Burgerhout,1973; Hsu,1979a,b), even though one should expect these data to be prime examples of the Normal law of errors, are mildly but definitely longer-tailed. It became apparent that the Normal distribution was no more usual than any other type. In fact, rather the reverse, so that the occurrence of a Normal distribution is to be regarded as something abnormal in navigation. The belief in the validity of the Normal law in the theory of navigational errors seems to die.

There are two observations, given by J.B. Parker in his comments on Andersons' paper (1965), as an explanation to the unsuitability of the Normal distribution:

"I believe, (Parker), there are two main reasons for this:

1. The data include a small proportion of non-random facts (e.g., blunders)
2. The data really come from two or more sources; even if these were separately Gaussian, there is no reason why the data taken together need be."

A plethora of research papers have been published to investigate the error distributions that arise in practice. At this stage, let us review some of the distributions which have been suggested in previous articles.

#### 2.10.2 Exponential

In the first place, a more appropriate model for describing large navigational errors (tails in a distribution) seemed to be the Exponential distribution. This was suggested by E.W.Anderson(1965), who arrived at his conclusion using astronomical observations and Doppler shifts. The general tendency of navigational errors to form an exponential function was also noticed by Abbott(1965), Crossley(1966), Lloyd(1966), Parker(1972), Anderson(1976), Hsu(1979a,b) etc.

It is worth mentioning that in navigation emphasis should be given to the occurrence of large errors (far-tail region) since this is of paramount importance to collision risk. The more pessimistic you are the safer your system will be. Hence, the key to making useful estimates of the degree of safety lies in the treatment given to the "tails" of probability distributions.

### 2.10.3 Two-parameter Models

In an attempt to justify the deficiencies of the Normal model, especially when many instruments and/or observers of different accuracies are involved, Anderson and Ellis (1971) proposed another error model. This was constructed by assuming that position errors have an underlying Normal distribution whose standard deviation ( $\sigma$ ) changes and which is approximated by a two-parameter family:

$$h(\sigma) = \frac{2}{\Gamma(\alpha)\beta^\alpha} \frac{1}{\sigma^{2\alpha+1}} \exp\left(-\frac{1}{\beta\sigma^2}\right), \quad (2.21)$$

where  $\alpha$  and  $\beta$  must be positive numbers and  $\beta$  is a scaling factor.

The deduced composite distribution is nothing else but a Pearson Type VII distribution (Johnson and Kotz, 1970, Vol.2, pp.13):

$$P(x; \alpha, \beta) = \frac{\Gamma(\alpha + \frac{1}{2})}{\Gamma(\alpha)} \sqrt{\frac{\beta}{2\pi}} \left(1 + \frac{\beta}{2} x^2\right)^{-(\alpha + \frac{1}{2})}. \quad (2.22)$$

It can be seen that if  $\beta = \frac{1}{\alpha}$  this distribution becomes the well-known Student's  $t$  distribution with  $2\alpha$  degrees of freedom. On the other hand, it is worth mentioning that this model should be considered with caution since it requires further verification using empirical data (Anderson and Ellis, 1971)

In addition to the above two-parameter family of distribution (eq.2.21), Parker (1972) considered the two-parameter Gamma frequency for the distribution of the standard deviation:

$$h(\sigma) = \frac{2\beta^\alpha}{\Gamma(\alpha)} \sigma^{2\alpha-1} \exp(-\beta\sigma^2) \quad . \quad (2.23)$$

#### 2.10.4 Compound Distributions

The involvement of several pilots, various aircraft, different instruments, etc. has as a consequence a variation in the overall standard deviation (Parker,1972). In an attempt to accommodate these variations to a model, Burgerhout (1973) recommended the special compound distribution already described in section 7 of compound distributions. The data used for this statistical analysis consisted of the lateral and vertical deviations of the actual flight paths from the desired ones. The data collection was performed by radar using 2400 instrument landing approaches. For a detailed description of the experiment and the derivation of the compound distribution see Burgerhout (1973).

#### 2.10.5 Double Exponential

The representation of position errors by a Double Exponential distribution (or first Laplace; or two-sided exponential) was first pointed out by Reich(1965) and later by Anderson and Ellis(1971).

### 2.10.6 Double Double Exponential

Hsu(1979b,1980) queried the use of a single error model and stressed the need for employing a mixture of error distributions, such as the Double Double Exponential and the Double Student's t distribution. In that respect, navigational errors are divided into two groups of contaminated (i.e., including blunders and/or members from different distributions) and of "ordinary" data. A statistical analysis (Hsu,1979b,1980) of several thousand data (7582 observations of aircraft lateral deviations) validated the idea of contamination (sometimes called dichotomy). Figure 2.9 depicts the observed position error distribution and the fitted distribution curves. It is noteworthy that the Double Double Exponential model fits observational data quite well.

### 2.10.7 Rayleigh

If errors are equal in two orthogonal directions (e.g., in latitude and longitude) and are Normally distributed, then one should expect that the radial errors follow a Rayleigh distribution. This is not the case in navigational practice. This happens because navigational data are almost always heterogeneous (Anderson and Ellis,1971). In 1978 a cruise in the Eastern Arctic showed that LORAN-C ranges verify the above conception of heterogeneity (Livingstone and Falconer,1980). According to Romanowski (Romanowski,1979) the term "heterogeneity" simply states that :



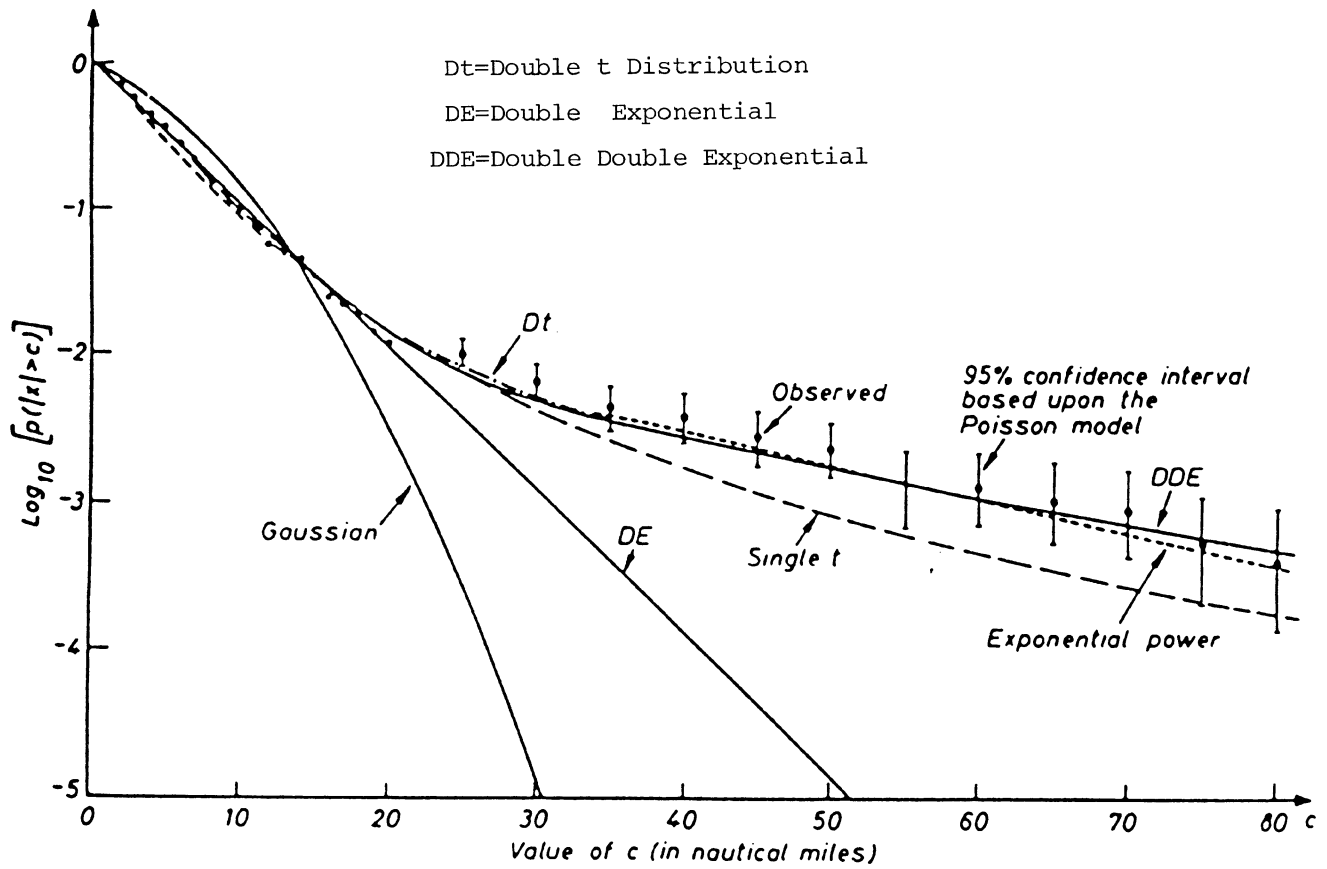

Figure 2.9

Observed position-error distribution and fitted distribution curves using 7582 observations of aircraft lateral deviations. (Hsu, 1980).

a certain set of measurements is an assemblage of loosely connected partial results or a collection of measurements made in different conditions, at different times and by different observers. It may also mean that an operation had been disturbed by a major accident (e.g., break down).

#### 2.10.8 Sinusoid

Another distribution that has appeared in navigation is the Sinusoid. In mid-1981, a LORAN-C data collection and analysis program in the St. Lawrence river has indicated that an admissible distribution for the across-track errors is the Sinusoid frequency (Slagle and Wenzel, 1982). This distribution seemed more suitable, particularly at the extremes of variation.

#### 2.10.9 Other Distribution Models

Lord and Overton (1971) and Rabone (1971) examined the incorporation of a series of analytic functions, such as numerical, Normex and rectangular distributions, to allow for the synthesis of the overall errors in navigation and the construction of a simulation program. The numerical distribution consists of a polynomial fit of fifth to seventh degree to the observational data. The Normex distribution resembles the Normal near the mean but exhibits higher values near the tails (exponential fit). Finally, the rectangular distribution was used for the simulation of blunders which have the same occurrence at any error magnitude. For a com-

plete description of the simulation program see Rabbone(1971).

Modelling of one-dimensional position errors as a function of time has been investigated by O.D. Anderson(1976). He considered position errors as random variables  $X_t$  whose distribution is Normal with zero mean but whose standard deviation increases with time (e.g., since the last fix), that is

$$x_t \sim N(0, \sigma^2 t^2) \quad (2.24)$$

where  $N(0, \sigma^2 t^2)$  is Normal with zero mean and variance  $\sigma^2 t^2$

In a recent paper, Kuebler and Sommers(1982) have summarized the accuracy of position fixes in terms of a cumulative distribution for most existing navigational systems (Omega, Transit, Integrated Transit/Omega, NAVSTAR, LORAN-C, Decca). They also pointed out that operational data from mainly sea trials follow a Weibull distribution (Johnson and Kotz,1970).

## 2.11 WHAT TO DO IN PRACTICE?

Given all these error distributions, there still remains the problem of what to do in practice. Should we rewrite the whole theory of position errors based on another distribution, such as the Double Exponential or should we still remain faithful to our familiar and simple model of the Normal

distribution? A simple answer to the above was attempted by J.B. Parker(1972):

For the general purposes, I (Parker) would favour replacing the Gaussian distribution, where it is patently inadequate, not by a multi-parameter family of distributions, however elegant, but by an open mind. Let the data speak for themselves, rather than subject them to a "two-parameter" strait-jacket."

Another hint was given by E.W. Anderson in his comments on Hsu's paper (1979a), who recommended the Double Exponential as opposed to the Normal:

No doubt simple rules of this sort (he means the Double Exponential) are dangerous, but perhaps not more dangerous than no rules at all. Perhaps Professor Hsu or some other expert will be prepared to open his mouth, and not flinch from the danger of putting his foot in it.

It seems appropriate that a general theory for the treatment of position errors in navigation is due. Along these lines, some suggestions are given in the last section of "conclusions and future trends".

### 3. ACCURACY MEASURES

Various accuracy measures have been attempted to characterize uncertainty in navigation. We shall refer to those ones which are most frequently used.

In most accuracy measures in current use, the estimating procedures are based on the assumption of Normality. In all of these investigations the Normal law comes to act as a veritable Procrustean bed to which all possible measurements and parameters should be made to fit. This is not surprising. Despite the preceding discussion on error distributions in navigation, it appears that the Normal law never introduces something that conflicts with the truth and its appearance in the description of navigational interval estimation has always the effect of approval and assurance. Be that as it may be. Accordingly, we are bringing it back into use as a natural assumption.

#### 3.1 HYPERELLIPSOIDS, ELLIPSOIDS AND ELLIPSES.

Let us consider a group  $\{\hat{x}_i, i=1, u\}$  of possibly related random variables that represent an estimate of a location parameter (for example, the three coordinates of a point):

$$\underline{\hat{x}} = (\hat{x}_1, \hat{x}_2, \dots, \hat{x}_u)^T \quad (3.1)$$

where the superscript ( $\hat{\quad}$ ) denotes estimator, the underbar vector and the superscript (T) the transpose.

Let us suppose that this random variable has an underlying multivariate Normal distribution with mean  $\underline{m}$  and covariance matrix  $C$  (Johnson and Wichern, 1982):

$$f(\hat{\underline{x}}; \underline{m}, C) = \frac{1}{(2\pi)^{u/2} |C|^{-1}} \exp\left\{-\frac{1}{2}(\hat{\underline{x}} - \underline{m})^T C^{-1} (\hat{\underline{x}} - \underline{m})\right\} \quad (3.2)$$

where  $|C|$  denotes the determinant of  $C$  and the superscript  $-1$  denotes the inverse. It should be noted that the mean value  $\underline{m}$  is a  $u$ -dimensional vector:

$$\underline{m} = [m_1, m_2, \dots, m_u]^T \quad (3.3)$$

such that  $m_i = E|x_i|$  and the covariance matrix  $C$  is defined in terms of the outer-product as follows:

$$\begin{aligned} C &= E[(\hat{\underline{x}} - \underline{m})(\hat{\underline{x}} - \underline{m})^T] = E[\hat{\underline{x}} \cdot \hat{\underline{x}}^T] - \underline{m} \cdot \underline{m}^T \\ &= \{\sigma_{ij}\} ; \quad i = 1, u \text{ and } j = 1, u \end{aligned} \quad (3.4)$$

such that  $\sigma_{ij} = E[(\hat{x}_i - m_i)(\hat{x}_j - m_j)]$

This covariance matrix is a symmetric positive definite matrix and therefore it has  $\lambda_1, \lambda_2, \dots, \lambda_u$  positive real eigenvalues (Johnson and Wichern, 1982).

We wish to construct simultaneous confidence intervals (or contours of equal probability) based on the joint distribution  $f(\hat{\underline{x}}; \underline{m}, C)$  of  $\hat{\underline{x}}$ . One popular solution in defining confidence intervals is to define such a region as to include points with probability exceeding some positive cons-

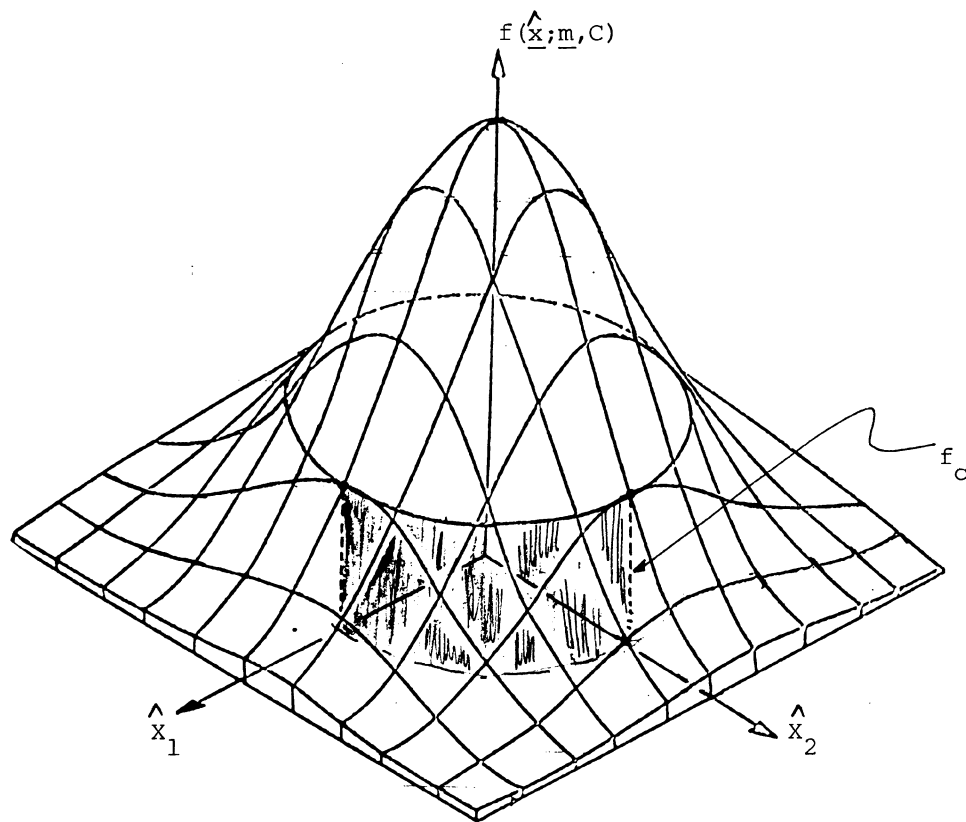

$\underline{m}=\underline{0}$  and  $u=2$

Figure 3.1: The Bivariate Normal Density Function

tant value  $f_c$  and to exclude the tails of the distribution where the density is below  $f_c$ . This is illustrated in the following Figure(3.1) when  $u=2$  and  $\underline{m}=0$ .

Therefore,

$$f(\underline{\hat{x}}; \underline{m}, C) \geq f_c = \text{constant}$$

(3.5)

which equivalently means that the exponent is

$$Q(\underline{\hat{x}}) = (\underline{\hat{x}} - \underline{m})^T C^{-1} (\underline{\hat{x}} - \underline{m}) \leq \text{constant} = k .$$

(3.6)

As we will see later, in the  $u$ -dimensional space the paths of  $\underline{\hat{x}}$ , which satisfy eq.(3.6) specify contours of constant probability density and generate a family of hyperellipsoids; in two dimensions the curve of an ellipse; in three dimensions the surface of an ellipsoid.

For symmetric matrices such as the covariance matrix  $C$ , a direct expansion known as spectral decomposition (Johnson and Wichern,1982) is defined as:

$$C = \lambda_1 (\underline{e}_1 \underline{e}_1^T) + \dots + \lambda_u (\underline{e}_u \underline{e}_u^T) ,$$

(3.7)

where  $\lambda_1, \lambda_2, \dots, \lambda_u$  are the eigenvalues of  $C$  and  $\underline{e}_1, \underline{e}_2, \dots, \underline{e}_u$  are the associated normalized eigenvectors. Thus

$$\underline{e}_i^T \underline{e}_j = \begin{cases} 1 & \text{for } i=j=1,2,\dots,u \\ 0 & \text{for } i \neq j \end{cases} \quad (3.8)$$



**Example.** In a three dimensional position fix determination, the coordinates

$$\underline{\hat{x}} = [\hat{x}_1, \hat{x}_2, \hat{x}_3]^T \quad (3.9)$$

were determined (e.g., using least squares) along with their covariance matrix:

$$C = \begin{bmatrix} 25 & 30 & -10 \\ 30 & 40 & -6 \\ -10 & -6 & 17 \end{bmatrix}$$

The characteristic equation (Johnson and Wichern, 1982) gives:

$$|C - \lambda I| = \lambda^3 - 82\lambda^2 + 1096\lambda - 400 = 0, \quad (3.10)$$

which has the following roots:

$$\lambda_1 = 65.86108$$

$$\lambda_2 = 15.75339$$

$$\lambda_3 = 0.38553$$

The normalized eigenvectors can be evaluated as:

$$\underline{e}_1 = \begin{bmatrix} 0.61170 \\ 0.76030 \\ -0.21855 \end{bmatrix}, \quad \underline{e}_2 = \begin{bmatrix} -0.08659 \\ 0.33896 \\ 0.93681 \end{bmatrix}, \quad \underline{e}_3 = \begin{bmatrix} 0.78634 \\ -0.55412 \\ 0.27318 \end{bmatrix}$$

It can be easily seen that:

$$C = \lambda_1 (\underline{e}_1 \underline{e}_1^T) + \lambda_2 (\underline{e}_2 \underline{e}_2^T) + \lambda_3 (\underline{e}_3 \underline{e}_3^T) \quad (3.11)$$

Let  $E$  be an orthogonal matrix whose columns are the normalized eigenvectors, that is:

if

$$E = [e_1 \quad e_2 \quad \dots \quad e_u]$$

(3.12)

then

$$C = \sum_{i=1}^u \lambda_i (e_i e_i^T) = E \Lambda E^T$$

(3.13)

where  $EE^T \equiv E^T E = I$  (orthogonal transformation) and  $\Lambda$  is a diagonal matrix:

$$\Lambda = \begin{bmatrix} \lambda_1 & 0 & \dots & 0 \\ 0 & \lambda_2 & \dots & 0 \\ \vdots & \vdots & \ddots & \vdots \\ 0 & 0 & \dots & \lambda_u \end{bmatrix}$$

(3.14)

Let us consider the transformation:

$$\underline{y} = E^T (\underline{\hat{x}} - \underline{m}) \quad \text{or} \quad (\underline{\hat{x}} - \underline{m}) = E \cdot \underline{y}$$

(3.15)

The quadratic form  $Q(x)$  then becomes:

$$\begin{aligned} Q(\underline{\hat{x}}) &= (\underline{\hat{x}} - \underline{m})^T C^{-1} (\underline{\hat{x}} - \underline{m}) = (E \cdot \underline{y})^T C^{-1} (E \cdot \underline{y}) = \underline{y}^T (E^T C^{-1} E) \underline{y} = \\ &= \underline{y}^T \Lambda^{-1} \underline{y} = \underline{y}^T [\text{diag}(\frac{1}{\lambda_i})] \underline{y} = \\ &= \frac{y_1^2}{\lambda_1} + \frac{y_2^2}{\lambda_2} + \dots + \frac{y_u^2}{\lambda_u} \end{aligned}$$

(3.16)

The equation:

$$\left. \begin{aligned} Q(\underline{\hat{x}}) &= (\underline{\hat{x}} - \underline{m})^T C^{-1} (\underline{\hat{x}} - \underline{m}) = Q(\underline{\hat{y}}) = \\ &= \frac{y_1^2}{\lambda_1} + \frac{y_2^2}{\lambda_2} + \dots + \frac{y_u^2}{\lambda_u} = k \end{aligned} \right\} \quad (3.17)$$

defines a family of hyperellipsoids generated by varying the constant  $k$ . This family of hyperellipsoids is centered at  $E[X] = \underline{m}$ . For a three dimensional solution ( $u=3$ ) a family of ellipsoids is formed which is illustrated in Figure (3.2).

In the new coordinate system,  $y_1, y_2, \dots, y_u$  are independent Normal variates lying in the direction of the eigenvectors  $e_{-1}, e_{-2}, \dots, e_{-u}$  respectively. They also represent the directions of maximum variability with semi-axes of the hyperellipsoid equal to:

$$\boxed{r_1 = \sqrt{\lambda_1 k} ; \quad r_2 = \sqrt{\lambda_2 k} ; \dots ; \quad r_u = \sqrt{\lambda_u k} .} \quad (3.18)$$

The volume of this  $u$ -dimensional hyperellipsoid is given by:

$$\text{volume} = V = \frac{\pi^{u/2}}{\Gamma(\frac{u}{2} + 1)} \prod_{i=1}^u r_i . \quad (3.19)$$

Since we are only rotating the coordinate system (orthogonal transformation), we are not affecting distances. Then the variability in the data defined as:

$$\text{var}(\hat{x}_1) + \dots + \text{var}(\hat{x}_u) = \sum_{i=1}^u \text{var}(\hat{x}_i) = \sum_{i=1}^u \sigma_i^2 , \quad (3.20)$$

remains unchanged.

Hence,

$$\left. \begin{aligned} \sum_{i=1}^u \text{var}(\hat{x}_i) &= \text{trace}(C) = \text{trace}(EE^T C) = \\ &= \text{trace}(E^T E C) = \text{trace}(\Lambda) = \\ &= \lambda_1 + \lambda_2 + \dots + \lambda_u = \sum_{i=1}^u \text{var}(y_i) . \end{aligned} \right\} \quad (3.21)$$

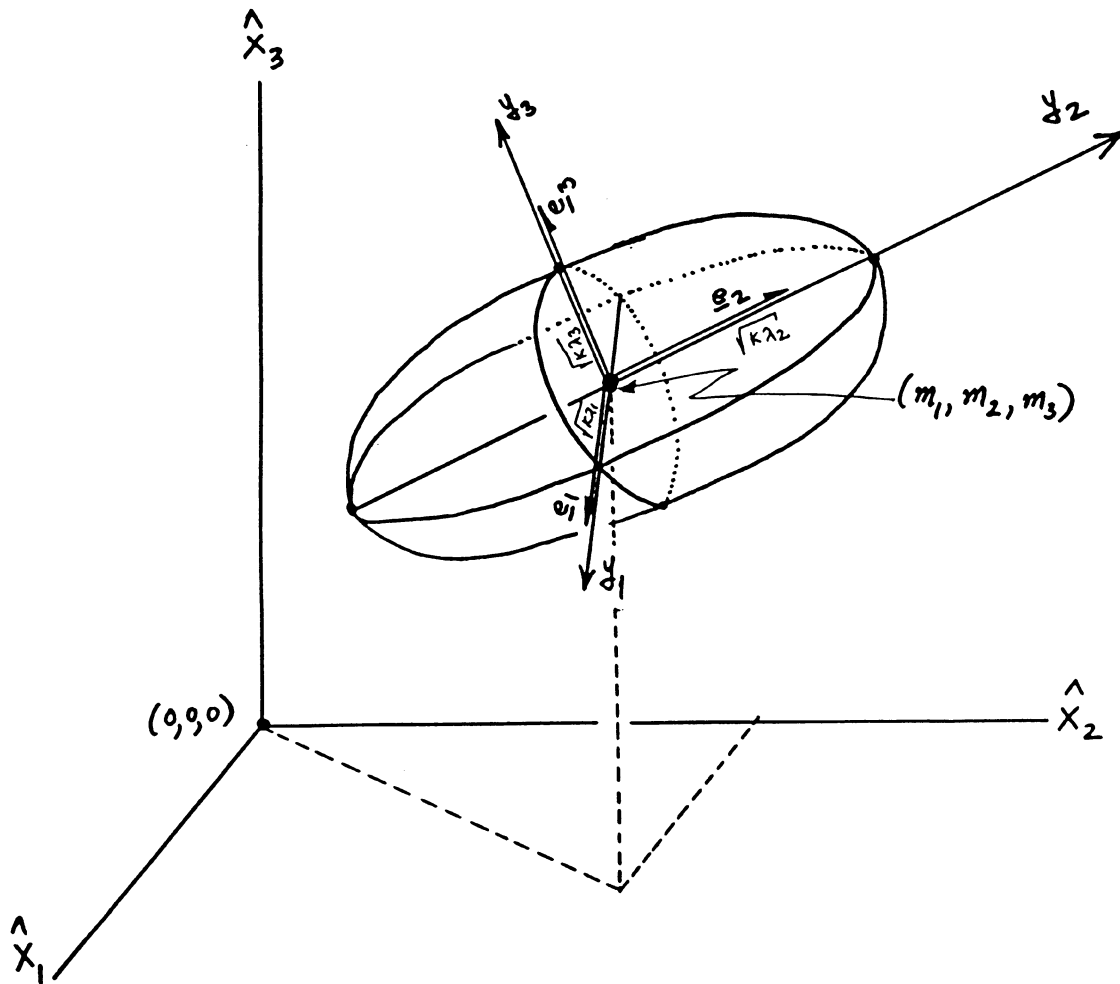

Figure 3.2 Ellipsoid of Constant Probability ( $u=3$ ).

In other words, the trace of the covariance matrix  $C$  is equal to the sum of its eigenvalues:

$$\text{trace}(C) = \lambda_1 + \lambda_2 + \dots + \lambda_u \quad . \quad (3.22)$$

The probability that  $x$  lies inside the surface of the hyper-ellipsoid is:

$$\begin{aligned} \Pr[\underline{\hat{x}} \text{ such that } Q(\underline{\hat{x}}) = (\underline{\hat{x}} - \underline{m})^T C^{-1} (\underline{\hat{x}} - \underline{m}) \leq k] &= F(k) = \\ &= \int \int \dots \int_{Q(\underline{\hat{x}}) \leq k} f(\underline{\hat{x}}; \underline{m}, C) d\hat{x}_1 \dots d\hat{x}_u = \\ &= \int \int \dots \int_{Q(\underline{y}) \leq k} f(\underline{y}; \underline{0}, \Lambda) |J| dy_1 \dots dy_u = \quad (3.23) \\ &= \int \int \dots \int_{Q(\underline{y}) \leq k} \frac{1}{(2\pi)^{u/2} |\Lambda|^{-1}} \exp\left(-\frac{1}{2} \underline{y}^T \Lambda^{-1} \underline{y}\right) dy_1 \dots dy_u = \\ &= \int \int \dots \int_{Q(\underline{y}) \leq k} \frac{1}{(2\pi)^{u/2} \sqrt{\lambda_1 \dots \lambda_u}} \exp\left(-\frac{1}{2} \underline{y}^T \Lambda^{-1} \underline{y}\right) dy_1 \dots dy_u , \end{aligned}$$

where  $|J|$  is the determinant of the jacobian transformation:

$$|J| = \left| \frac{\partial \underline{\hat{x}}}{\partial \underline{y}} \right| = | I \text{ (identity matrix)} | = 1 \quad . \quad (3.24)$$

Moreover, if we apply the transformation:

$$\boxed{z_i = \frac{y_i}{\sqrt{\lambda_i}} \quad , \quad i = 1, u \quad ,} \quad (3.25)$$

the new variates  $z_i$  are Normally distributed with zero mean and identity covariance matrix ( $\mathbf{I}$ ). Accordingly, the probability of being located within the hyperellipsoid becomes:

$$\begin{aligned}
 F(k) &= \Pr[\hat{\underline{x}}: Q(\hat{\underline{x}}) = (\hat{\underline{x}} - \underline{m})^T \mathbf{C}^{-1} (\hat{\underline{x}} - \underline{m}) \leq k] = \\
 &= \int \int \dots \int_{Q(\underline{y}) \leq k} \frac{1}{(2\pi)^{u/2} \sqrt{\lambda_1 \dots \lambda_u}} \exp\left(-\frac{1}{2} \underline{y}^T \Lambda^{-1} \underline{y}\right) dy_1 \dots dy_u = \\
 &= \int \int \dots \int_{Q(\underline{z}) \leq k} \frac{1}{(2\pi)^{u/2}} \exp\left(-\frac{1}{2} \underline{z}^T \underline{z}\right) dz_1 \dots dz_u \quad ,
 \end{aligned}$$

(3.26)

where the determinant of the jacobian of the above transformation is:

$$\left| \frac{d\underline{y}}{d\underline{z}} \right| = \sqrt{\lambda_1 \lambda_2 \dots \lambda_u} = \sqrt{|\Lambda|} = \sqrt{|c|} \quad ,$$

(3.27)

and the region of integration of the new quadratic form becomes

$$\boxed{Q(\underline{z}) = z_1^2 + z_2^2 + \dots + z_u^2 \leq k} \quad .$$

(3.28)

It can be easily seen that since  $z_i$  are standardized Normal variates the distribution of the quadratic form  $Q(\underline{z}) = \underline{z}^T \underline{z}$  (sum of the squares of standardized Normal variates) follows a chi-square distribution with  $u$  degrees of freedom.

Therefore, the hyperellipsoid of  $x$  values satisfying:

$$\boxed{(\hat{\underline{x}} - \underline{m})^T C^{-1} (\hat{\underline{x}} - \underline{m}) \leq \chi_u^2(\alpha)} \quad (3.29)$$

$\chi_u^2(\alpha)$ : When the covariance matrix  $C$  is unknown, then the Fischer's distribution should be used. In other words,  $\chi_u^2(\alpha)$  should be replaced by  $F(\alpha; u, df)$ , where  $df$  = number of redundant observations.)

has probability  $1-\alpha$

**Example:** Using the data of the previous example for the eigenvalues, the three dimensional ellipsoid ( $u=3$ ) will be obtained as follows: If the desired significance level  $\alpha$  is, say 5%, then the  $1-\alpha = 1-0.05 = 95\%$  confidence ellipsoid is defined by:

$$\frac{y_1^2}{\lambda_1} + \frac{y_2^2}{\lambda_2} + \frac{y_3^2}{\lambda_3} \leq \chi_3^2(\alpha) = \chi_3^2(0.05) = 7.81 \quad (3.30)$$

with semi-axes:

$$\begin{aligned} r_1 &= \sqrt{k\lambda_1} = \sqrt{\chi_3^2(\alpha)\lambda_1} = \sqrt{7.81 \times 65.86} = 22.68 \text{ m} \\ r_2 &= \sqrt{k\lambda_2} = \sqrt{\chi_3^2(\alpha)\lambda_2} = \sqrt{7.81 \times 15.75} = 11.09 \text{ m} \\ r_3 &= \sqrt{k\lambda_3} = \sqrt{\chi_3^2(\alpha)\lambda_3} = \sqrt{7.81 \times 0.38} = 1.73 \text{ m} \end{aligned} \quad (3.31)$$

In the two dimensional case, the confidence ellipse is defined by:

$$\frac{y_1^2}{\lambda_1} + \frac{y_2^2}{\lambda_2} \leq \chi_2^2(\alpha) \quad (3.32)$$

For a certain significance level  $\alpha$ , the semi-major and the semi-minor axes of the  $(1-\alpha)$  confidence ellipse can be obtained by:

$$\left. \begin{aligned} r_1 &= \text{semi-major} = \sqrt{k\lambda_1} = \sqrt{\chi_2^2(\alpha)\lambda_1} \\ r_2 &= \text{semi-minor} = \sqrt{k\lambda_2} = \sqrt{\chi_2^2(\alpha)\lambda_2} \end{aligned} \right\} \quad (3.33)$$

In this particular case, the covariance matrix C is given as:

$$C = \begin{bmatrix} \sigma_1^2 & \sigma_{12} \\ \sigma_{12} & \sigma_2^2 \end{bmatrix} \quad (3.34)$$

and the corresponding eigenvalues (Vanicek and Krakiwsky, 1982):

$$\left. \begin{aligned} \lambda_1 &= \frac{1}{2} \left[ \sigma_1^2 + \sigma_2^2 + \sqrt{(\sigma_1^2 - \sigma_2^2)^2 + 4\sigma_{12}^2} \right] \\ \lambda_2 &= \frac{1}{2} \left[ \sigma_1^2 + \sigma_2^2 - \sqrt{(\sigma_1^2 - \sigma_2^2)^2 + 4\sigma_{12}^2} \right] \end{aligned} \right\} \quad (3.35)$$

The rotated ellipse (see Figure 3.3), in the uncorrelated system  $(y_1, y_2)$ , is obtained by applying the following transformation:

$$\underline{y} = E^T (\underline{\hat{x}} - \underline{m}) \quad , \quad (3.36)$$

where E is a rotation matrix (orthogonal):

$$E = \begin{bmatrix} \cos\theta & -\sin\theta \\ \sin\theta & \cos\theta \end{bmatrix} \quad (3.37)$$



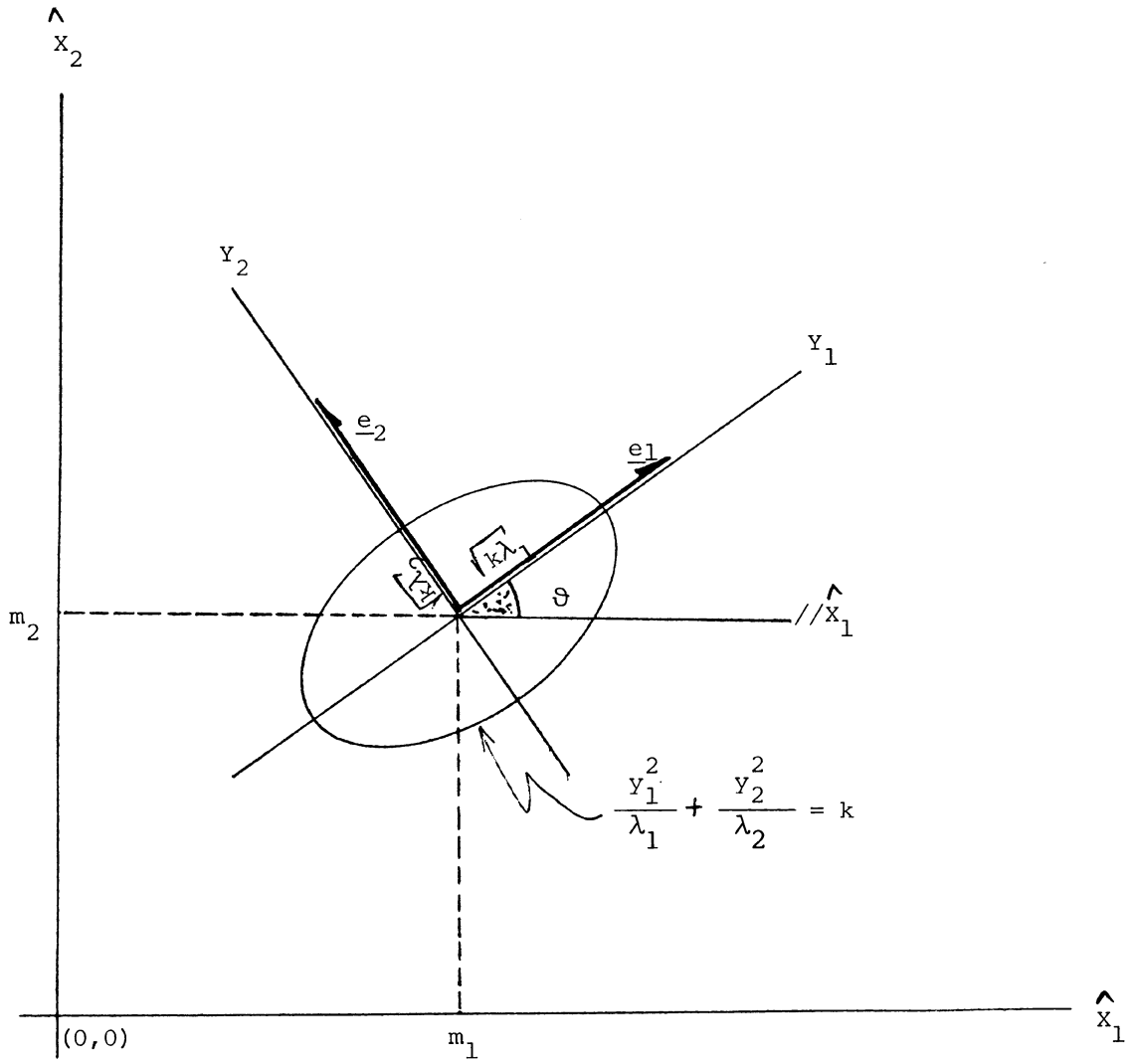

Figure 3.3: Confidence Ellipse (u=2)

The rotation angle  $\theta$  (theta) is given (Vanicek and Krakiwsky, 1982):

$$\theta = \frac{1}{2} \tan^{-1} \left( \frac{2\sigma_{12}}{\sigma_1^2 - \sigma_2^2} \right) ; \quad -\frac{\pi}{4} \leq \theta \leq \frac{\pi}{4} \quad (3.38)$$

Figure (3.4) shows an ellipse centered at  $(m_1, m_2)$  with unequal eigenvalues  $(\lambda_1 \neq \lambda_2)$ . The next Figure (3.5) depicts a trivial case of a circular confidence region, where the eigenvalues of the covariance matrix  $C$  are equal  $(\lambda_1 = \lambda_2)$ . Both regions, though, encompass a certain probability that can be evaluated by:

$$F(k) = \text{pr} \left[ (\hat{x}_1, \hat{x}_2) : (\hat{x} - \underline{m})^T C^{-1} (\hat{x} - \underline{m}) \leq k \right] \quad (3.39)$$

Table (1) and (2) give values of  $k = \sqrt{\chi_u^2(\alpha)}$  by which the square roots of the eigenvalues  $(\lambda_i, i=1, 2, \dots, u)$  for a standard ellipsoid or ellipse ( $k=1$ ) should be multiplied to obtain different confidence regions (e.g., 99%, 95%, 50% etc.).

As previously mentioned, the volume of the  $u$ -dimensional hyperellipsoid is given by:

$$V = \frac{\pi^{u/2}}{\Gamma(\frac{u}{2} + 1)} \prod_{i=1}^u r_i \quad (3.40)$$

Therefore, the volume of a hypersphere with radius  $\rho$  equal to:

$$\rho = \sqrt{z_1^2 + z_2^2 + \dots + z_u^2} = \sqrt{k} \quad (3.41)$$

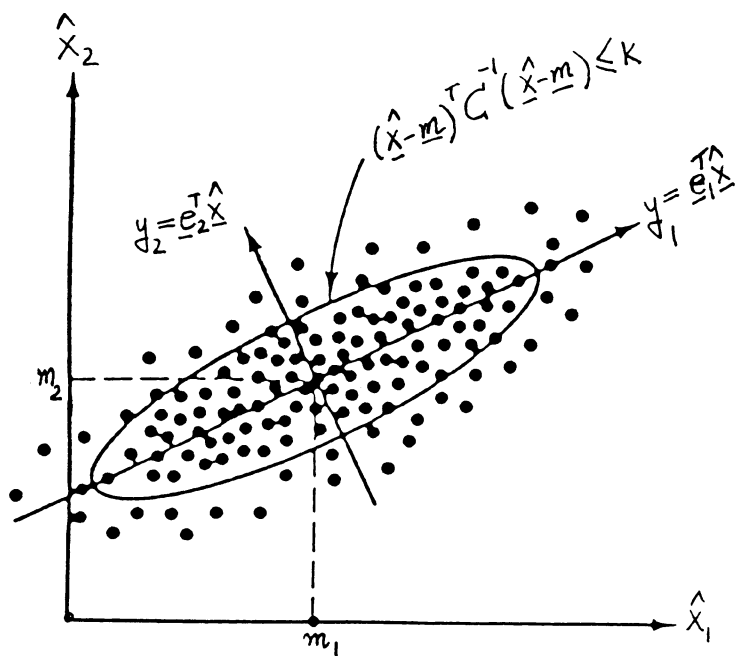

Figure 3.4: Confidence Ellipse With Unequal Eigenvalues.

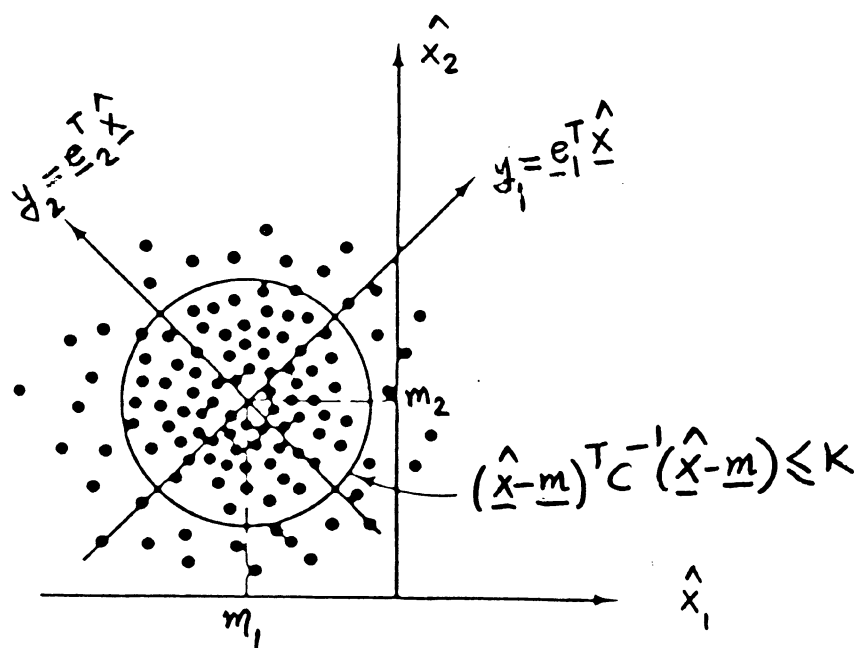

Figure 3.5: Confidence Ellipse With Equal Eigenvalues.

Multiple of a Standard Error Ellipsoid Parameters	Probability of a Fix Being Within the Derived Error Ellipsoid
$(\sqrt{k} = \sqrt{\chi_3^2(\alpha)})$	(percent) $(1 - \alpha)$
3.58	99.5
3.37	99.0
3.06	97.5
2.79	95.0
2.50	90.0
1.54	50.0
0.76	10.0
0.59	5.0
0.33	1.0

TABLE 1  
Probability of Various Error Ellipsoids

Multiple of a Standard Error Ellipse Parameters	Probability of a Fix Being Within the Derived Error Ellipse
$\{\sqrt{k} = \sqrt{\chi_2^2(\alpha)} = \sqrt{-2 \ln(\alpha)}\}$	(percent) $(1 - \alpha)$
3.256	99.5
3.035	99.0
2.717	97.5
2.447	95.0
2.147	90.0
1.178	50.0
0.458	10.0
0.316	5.0
0.141	1.0

TABLE 2  
Probability of Various Error Ellipses

will be evaluated as (Torrieri,1984):

$$V(\rho) = \frac{\pi^{u/2} \rho^u}{\Gamma(\frac{u}{2} + 1)} \quad (3.42)$$

The probability of being located within a region of constant radius  $\rho$  given by eq(3.26) can be expressed as:

$$\begin{aligned} F(k) &= \Pr[(z_1, z_2, \dots, z_u): \rho = \sqrt{z_1^2 + z_2^2 + \dots + z_u^2} \leq \sqrt{k}] = \\ &= \frac{1}{(2\pi)^{u/2}} \int \int \dots \int_{\underline{Q}(\underline{z}) \leq k} \exp[-\frac{1}{2}(z_1^2 + \dots + z_u^2)] dz_1 \dots dz_u = \\ &= \frac{1}{(2\pi)^{u/2}} \int_0^{\sqrt{k}} \exp[-\frac{1}{2} \rho^2] dV = \\ &= \frac{1}{(2\pi)^{u/2}} \int_0^{\sqrt{k}} \exp(-\frac{1}{2} \rho^2) \left( \frac{u\pi^{u/2} \rho^{u-1}}{\Gamma(\frac{u}{2} + 1)} \right) d\rho = \\ &= \frac{u}{2^{u/2} \Gamma(\frac{u}{2} + 1)} \int_0^{\sqrt{k}} \rho^{u-1} \exp(-\frac{1}{2} \rho^2) d\rho \quad . \quad (3.43) \end{aligned}$$

It should be noted that the above integral for  $u=1$  (one-dimensional)  $u=2$  (two-dimensional) and  $u=3$  (three-dimensional) can be evaluated as follows (Torrieri,1984):

$$\left. \begin{aligned} u=1 &: F(k) = \operatorname{erf}\left(\sqrt{\frac{k}{2}}\right) \\ u=2 &: F(k) = 1 - \exp\left(-\frac{k}{2}\right) \\ u=3 &: F(k) = \operatorname{erf}\left(\sqrt{\frac{k}{2}}\right) - \sqrt{\frac{2k}{\pi}} \exp\left(-\frac{k}{2}\right) \end{aligned} \right\} \quad (3.44)$$

where the  $\text{erf}(\ )$  represents the error function associated with the Normal curve and is defined by:

$$\text{erf}x = \frac{2}{\sqrt{\pi}} \int_0^x \exp(-t^2) dt \quad (3.45)$$

or equivalently

$$\int_0^t f(x;0,1) dx = \frac{1}{2} \text{erf}\left(\frac{t}{\sqrt{2}}\right) .$$

The function  $f(x;0,1)$  represents the Normal probability density function with zero mean and unit variance.

### 3.2 RADIAL ERRORS

Instead of using ellipsoids and ellipses, it is often convenient to use spheres and circles with particular probability confidence levels. This concept of spherical or circular probability confidence levels originated actually from military applications in bombing (Laurent,1957; Edmundson,1961; Harter,1960; Zacks and Solomon,1975; Olsen,1977). There the main interest is to calculate the probability of damage or impact to a target (you are either on or off the target). The same notion is applicable to navigation (Hiraiwa,1967;1980). Navigators have been interested in the probability of being located within a region of constant radius. In the following section we will deal with the radial errors as a measure of variability in sampling.

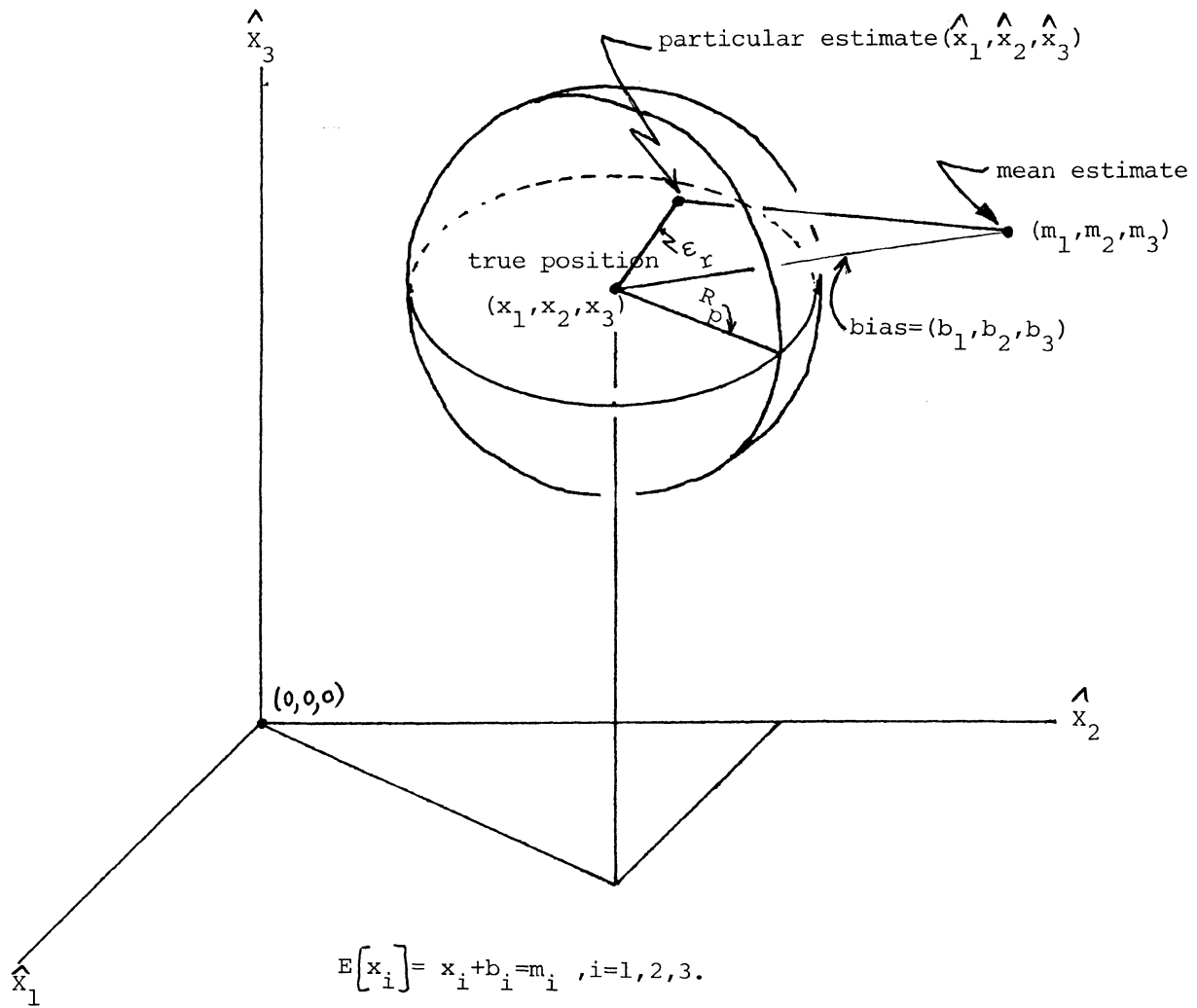

Figure 3.6: Radial Error in the Three-dimensional Case.

A measure of considerable importance in navigation is the radius of a sphere (or circle)  $R_p$  centered at the mean  $\underline{m}=(m_1, m_2, \dots, m_u)$  and which sphere contains a given proportion  $p$  of the distribution under consideration (in our case Normal). We, therefore, wish to find the probability that the distance for an unbiased estimator:

$$\varepsilon_r = \sqrt{(\hat{x}_1 - x_1)^2 + \dots + (\hat{x}_u - x_u)^2} \quad (3.46)$$

will be less than or equal to a chosen value  $R_p$ . The above defined quantity ( $\varepsilon_r$ ) is called the radial error. The different moments of this error, such as the mean  $E|\varepsilon_r|$  and the variance  $\text{Var}|\varepsilon_r^2|$ , have been examined by Scheuer(1962), Edmundson(1961) and Childs et al.(1978), while its distribution has been studied by Weil(1954).

For a three dimensional case ( $u=3$ ), the problem is depicted geometrically in Figure (3.6). In this Figure, the point  $(m_1, m_2, m_3) = (E[x_1], E[x_2], E[x_3])$  is the expected value of some location parameter  $\underline{x}=(x_1, x_2, x_3)$ , while  $\underline{\hat{x}}=(\hat{x}_1, \hat{x}_2, \hat{x}_3)$  represents the position coordinates of a particular estimate.

If we assume that our estimate  $\underline{\hat{x}}=(\hat{x}_1, \hat{x}_2, \hat{x}_3)$  is unbiased, that is:

$$E[\hat{x}_i] = m_i = x_i \quad ; \quad i=1,2,\dots,u \quad (3.47)$$

then the radial error is defined as:



$$\varepsilon_r = \sqrt{(\hat{x}_1 - m_1)^2 + \dots + (\hat{x}_u - m_u)^2} \quad (3.48)$$

The probability  $p = F(R_p)$  that a point  $\hat{\underline{x}} = (\hat{x}_1, \hat{x}_2, \hat{x}_3)$ , taken at random, will fall within a hyperspherical surface whose center is at  $(m_1, m_2, \dots, m_u)$  can be evaluated as:

$$p = F(R_p) = \int \int \dots \int_{\varepsilon_r \leq R_p} f(\hat{\underline{x}}; \underline{m}, C) d\hat{x}_1 \dots d\hat{x}_u \quad (3.49)$$

where the region of integration is:

$$\varepsilon_r = \sqrt{(\hat{x}_1 - m_1)^2 + \dots + (\hat{x}_u - m_u)^2} \leq R_p \quad (3.50)$$

Under Normality, the above statement (eq. 3.49) can be written :

$$p = F(R_p) = \int \int \dots \int_{\varepsilon_r \leq R_p} \frac{1}{(2\pi)^{u/2} |C|^{-1}} \exp\left[-\frac{1}{2}(\hat{\underline{x}} - \underline{m})^T C^{-1} (\hat{\underline{x}} - \underline{m})\right] d\hat{x}_1 \dots d\hat{x}_u \quad (3.51)$$

If we diagonalize the covariance matrix  $C$  (translate and rotate the coordinates) we obtain:

$$p = F(R_p) = \int \int \dots \int_{\varepsilon_r \leq R_p} \frac{1}{(2\pi)^{u/2} \sqrt{\lambda_1 \dots \lambda_u}} \exp\left\{-\frac{1}{2} \underline{y}^T \Lambda^{-1} \underline{y}\right\} dy_1 \dots dy_u \quad (3.52)$$

-where  $\lambda_1, \lambda_2, \dots, \lambda_u$  are the eigenvalues of the covariance matrix

- $y_i, i=1, u$  are Normal uncorrelated variates with variances:

$$\text{var}(y_i) = \lambda_i, \quad i=1, 2, \dots, u \quad (3.53)$$

-and  $\Lambda$  is a diagonal matrix whose diagonal contains the eigenvalues  $\lambda_1, \lambda_2, \dots, \lambda_u$  of the covariance matrix  $C$ .

Equivalently, equation (3.52) can be written:

$$p = F(R_p) = \frac{1}{(2\pi)^{u/2} \sqrt{\lambda_1 \dots \lambda_u}} \int_{\epsilon_r \leq R_p} \dots \int \exp\left[-\frac{1}{2}\left(\frac{y_1^2}{\lambda_1} + \dots + \frac{y_u^2}{\lambda_u}\right)\right] dy_1 \dots dy_u \quad (3.54)$$

The region of integration, based on eq(3.50) and on the orthogonal transformation :

$$(\underline{\hat{x}} - \underline{m}) = E \cdot \underline{y} \quad (3.55)$$

becomes

$$\begin{aligned} \sqrt{(\hat{x}_1 - m_1)^2 + \dots + (\hat{x}_u - m_u)^2} &= \sqrt{(\underline{\hat{x}} - \underline{m})^T (\underline{\hat{x}} - \underline{m})} = \sqrt{(E \cdot \underline{y})^T (E \cdot \underline{y})} = \\ &= \sqrt{\underline{y}^T (E^T E) \underline{y}} = \sqrt{\underline{y}^T I \underline{y}} = \sqrt{y_1^2 + \dots + y_u^2} \leq R_p \end{aligned} \quad (3.56)$$

### 3.2.1 Radial Probable Error

A common probability level used, for most navigation work (Burt et al., 1966; Johnson et al., 1969), is that of 50 percent, for which our position ( $\underline{\hat{x}}$ ) will fall inside a hypersphere (sphere for  $u=3$  and circle for  $u=2$ ). This kind of deduced radius is called **radial probable error** ( $R_{pe}$ ) and it is defined as follows:

$$\frac{1}{2} = p = F(R_{pe}) = \int_{m_1 - R_{pe}}^{m_1 + R_{pe}} \dots \int_{m_u - R_{pe}}^{m_u + R_{pe}} f(\underline{\hat{x}}; \underline{m}, C) d\hat{x}_1 \dots d\hat{x}_u \quad (3.57)$$

### 3.2.2 Circular and Spherical Probable Errors

The radial probable error in the two- and three-dimensional cases is, respectively, called the Circular Probable Error (CPE or CEP) and Spherical Probable Error (SPE or SEP). Hence, the CPE is defined as the radius of a circle which contains 50 percent of all possible fixes that can be obtained with a navigation system at any place (Burt et al., 1966). In the same way, the SPE is defined as the radius of a sphere such that 50 percent of our position estimates will fall inside the sphere (Childs et al., 1978).

Figure (3.8) illustrates the relationship of two quadratic forms. One represents the circular confidence level, whereas the other the equivalent error ellipse.

From eq.(3.57), the joint probability function  $F(R_{pe})$  for the three-dimensional case, becomes:

$$P=F(SPE) = \frac{1}{(2\pi)^{3/2} \sqrt{\lambda_1 \lambda_2 \lambda_3}} \int_{\epsilon_r < SPE} \int \int \exp\left[-\frac{1}{2}\left(\frac{y_1^2}{\lambda_1} + \frac{y_2^2}{\lambda_2} + \frac{y_3^2}{\lambda_3}\right)\right] dy_1 dy_2 dy_3$$

(3.58)

where the region of integration is:

$$\epsilon_r = \sqrt{y_1^2 + y_2^2 + y_3^2} \leq \text{SPE} \quad (3.59)$$

In the two-dimensional case, the joint probability is:

$$p=F(\text{CPE}) = \frac{1}{2\pi\sqrt{\lambda_1\lambda_2}} \int \int_{\epsilon_r \leq \text{CPE}} \exp\left[-\frac{1}{2}\left(\frac{y_1^2}{\lambda_1} + \frac{y_2^2}{\lambda_2}\right)\right] dy_1 dy_2 \quad (3.60)$$

where again the region of integration is:

$$\epsilon_r = \sqrt{y_1^2 + y_2^2} \leq \text{CPE} \quad (3.61)$$

An exact solution of the above integrals can be evaluated by transforming the Cartesian coordinates into spherical or polar ones, but most of the derived expressions (Johnson,1969; Harter,1960; Weingarten and DiDonato,1961; Gilliland,1962; Burt et al.,1966; Isley,1980; Torrieri,1984) require numerical techniques in their evaluation. Many an exact solution has been given considering the spherical or the circular (Rayleigh) Normal distribution (Edmundson, 1961). Grad and Solomon(1955) have also investigated the general problem of the distribution of quadratic forms of the kind:

$$Q_k = \sum_{i=1}^k a_i x_i^2 ; \quad \sum_{i=1}^k a_i = 1 ; \quad a_i > 0 \quad (3.62)$$

for  $x_i$  Normally and independently distributed with zero mean and unit variance. They have also provided the exact and ap-

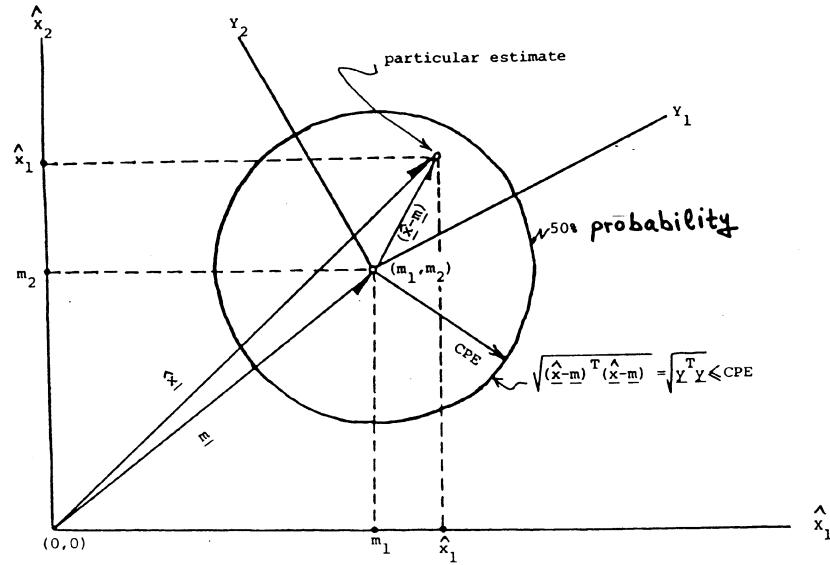

Figure 3.7: Geometrical Depiction of the CPE Circle.

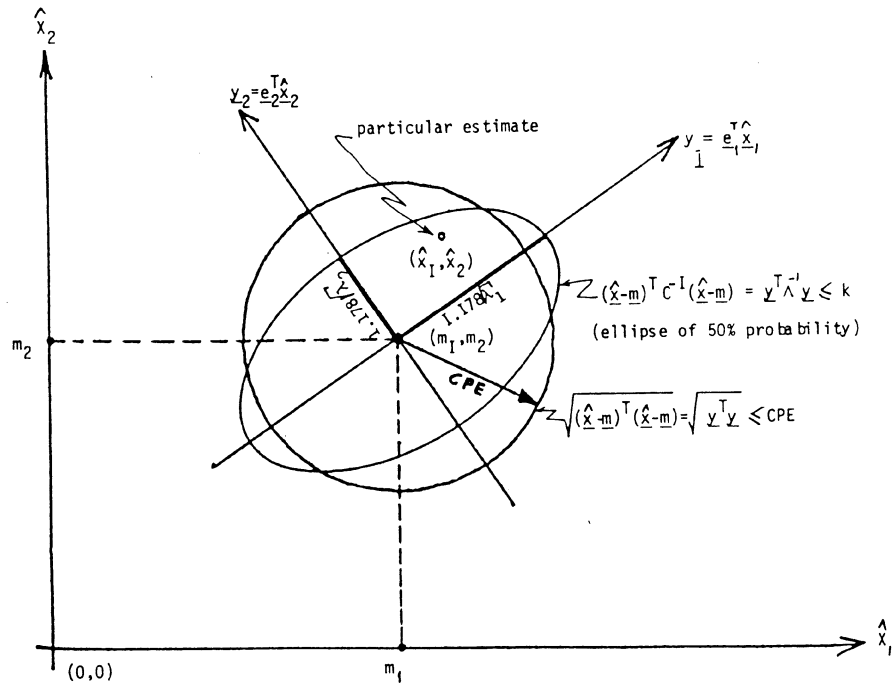

Figure 3.8: Relationship of the CPE circle and the Equivalent Error Ellipse.

proximate forms of the distribution of the above quadratic form.

Some analytical approximations to eq.(3.58) and (3.60) are also available. Grubbs(1964), using a Wilson-Hilferty transformation, approximated the distribution of a quadratic form for a biased estimator, (e.g.,  $\epsilon_r^2 = (\hat{x}_1 - x_1)^2 + \dots + (\hat{x}_u - x_u)^2$ ), by a standard Normal variable expressed as:

$$z = \frac{\sqrt[3]{\frac{R_p^2}{\sigma_{m_Q}^2}} - \left(1 - \frac{\sigma_Q^2}{9m_Q}\right)}{\sqrt{\frac{\sigma_Q^2}{9m_Q}}} \quad (3.63)$$

where  $m_Q$  and  $\sigma_Q^2$  are the mean and variance of the quadratic form ( $\epsilon_r^2$ ) given by:

$$m_Q = E[\epsilon_r^2] = 1 + \sum_{i=1}^u \frac{(m_{Y_i} - Y_i)^2}{\sigma^2} \quad \text{and} \quad (3.64)$$

$$\sigma_Q^2 = \text{var}[\epsilon_r^2] = 2 \left\{ \sum_{i=1}^u \frac{\sigma_i^4}{\sigma^4} + 2 \sum_{i=1}^u \left(\frac{\sigma_i}{\sigma}\right) \left[\frac{m_{Y_i} - Y_i}{\sigma}\right]^2 \right\} \quad (3.65)$$

where

$$\sigma^2 = \sigma_1^2 + \dots + \sigma_u^2 = \lambda_1 + \dots + \lambda_u = \sum_{i=1}^u \text{var}(Y_i) \quad (3.66)$$

To determine the approximate value for CPE or SPE, we equate eq.(3.63) to zero and solve for the radius  $R_p$ . In a such a way, we obtain the radial distance that includes 50 percent

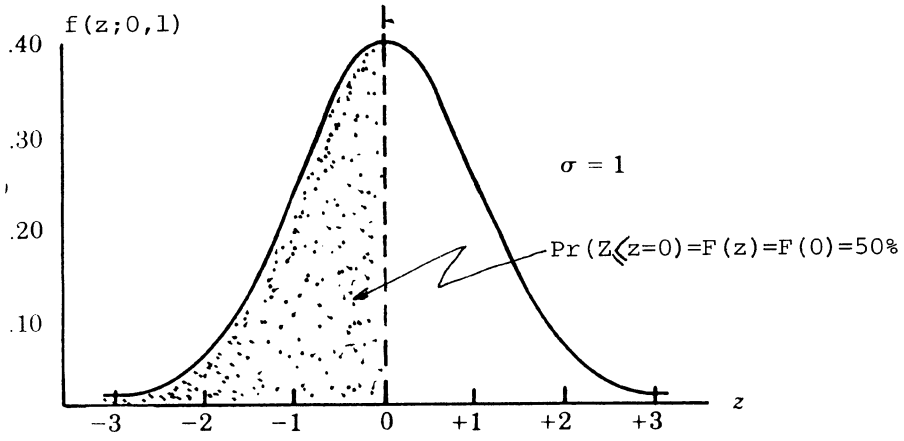

Figure 3.9: Determination of CPE and SPE Using a Standard Normal

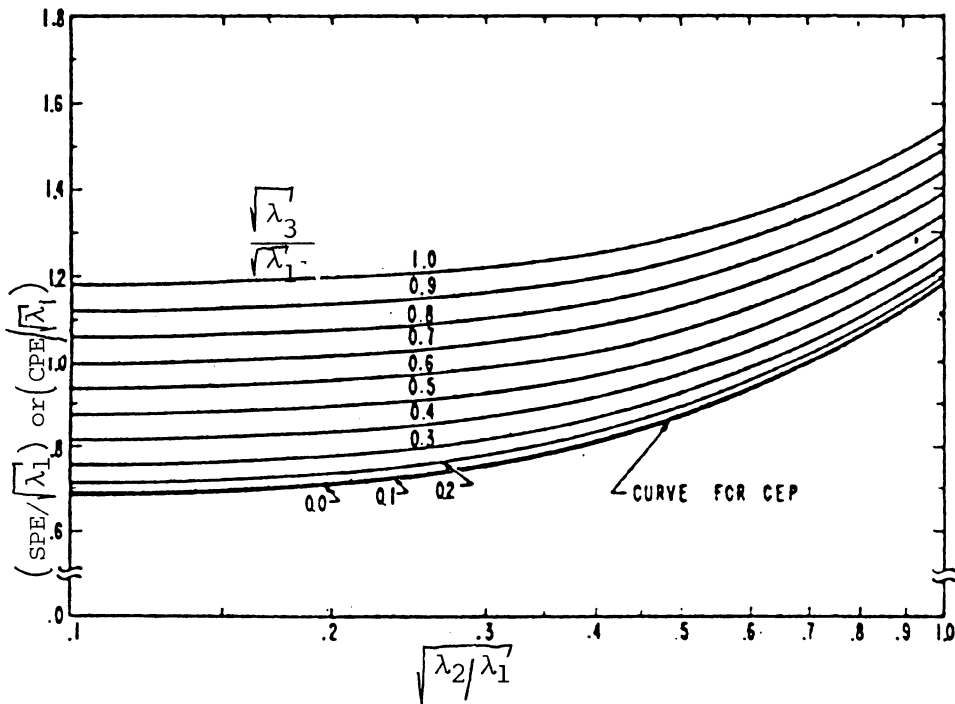

Figure 3.10: Results of Numerical Integration

of the points (fixes), (see also Figure 3.9). Therefore, for an unbiased estimator (e.g.,  $(b_1, b_2, b_3) = (0, 0, 0)$ ) the approximate values for CPE and SPE can be obtained by:

$$\begin{aligned}
 \text{For } u = 2 : \quad \text{CPE} &\cong \sigma \sqrt{\left(1 - \frac{\sigma_Q^2}{9m_Q}\right)^3} \\
 \text{where} \quad \sigma &= \sqrt{\sigma_1^2 + \sigma_2^2} = \sqrt{\lambda_1 + \lambda_2} \\
 \sigma_Q^2 &= 2\left(\frac{\lambda_1^2 + \lambda_2^2}{\sigma^4}\right), \quad m_Q = 1 \\
 \\
 \text{For } u = 3 : \quad \text{SPE} &\cong \sigma \sqrt{\left(1 - \frac{\sigma_Q^2}{9m_Q}\right)^3} \\
 \text{where} \quad \sigma &= \sqrt{\sigma_1^2 + \sigma_2^2 + \sigma_3^2} = \sqrt{\lambda_1 + \lambda_2 + \lambda_3} \\
 \sigma_Q^2 &= 2\left(\frac{\lambda_1^2 + \lambda_2^2 + \lambda_3^2}{\sigma^4}\right), \quad m_Q = 1
 \end{aligned} \tag{3.67}$$

Figure (3.10) shows the results of a numerical integration performed by Johnson et al. (1969). The diagram depicts the value  $\text{SPE}/\sqrt{\lambda_1}$  as a function of  $\sqrt{\frac{\lambda_2}{\lambda_1}}$  for various  $\sqrt{\frac{\lambda_3}{\lambda_1}}$ . There the eigenvalues satisfy the inequality  $\lambda_1 > \lambda_2 > \lambda_3$ , without loss of generality. The limiting case, for which  $\sqrt{\frac{\lambda_3}{\lambda_1}} = 0$ , provides values for the CPE. Another diagram of Figure (3.11) shows the exact and the approximate relationships of  $\text{CPE}/\sqrt{\lambda_1}$  with  $\sqrt{\frac{\lambda_2}{\lambda_1}}$  (Burt et al., 1966).

In the two-dimensional case, where  $\sigma_1 = \sigma_2 = \sigma$  and  $\sigma_{12} = 0$  (circular Normal or Rayleigh distribution), it can be easily found that:



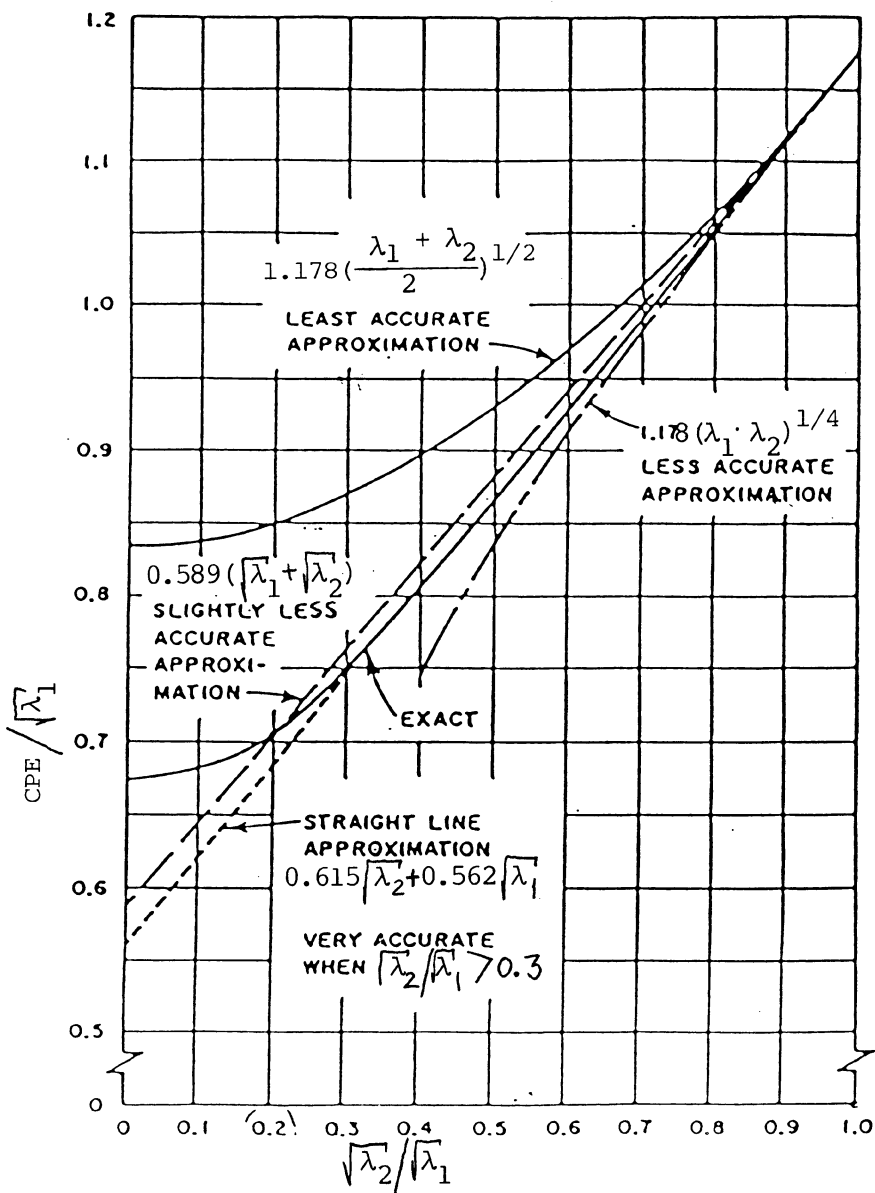

Figure 3.11: Exact and approximate forms of CPE

$$\text{CPE} = 1.178\sigma \quad (3.69)$$

In the more general case where  $\lambda_1 \neq \lambda_2$ , Torrieri(1984) gives an approximation (10% underestimation) for the CPE and when  $0.1 < \sqrt{\frac{\lambda_2}{\lambda_1}} < 0.3$ , as:

$$\text{CPE} \approx 0.563 \sqrt{\lambda_1} + 0.614 \sqrt{\lambda_2} \quad (3.70)$$

Other kinds of approximation can be found in the previous diagram of Figure (3.11) given by Burt et al.(1966).

### 3.2.3 Geometrical Mean Error

The approximation

$$\text{CPE} \approx 1.178(\lambda_1 \lambda_2)^{1/4}, \quad u = 2 \quad (3.71)$$

defines another accuracy measure known as the Geometrical Mean Error (GME). This is derived by assuming that the circle of radius GME has the same area as the 50 percent error ellipse (Childs et al.,1978). On the other hand, Childs et al.(1978) give the following approximation pertinent to the three-dimensional case

$$\text{GME} \approx 1.539(\lambda_1 \lambda_2 \lambda_3)^{1/6}, \quad u = 3 \quad (3.72)$$

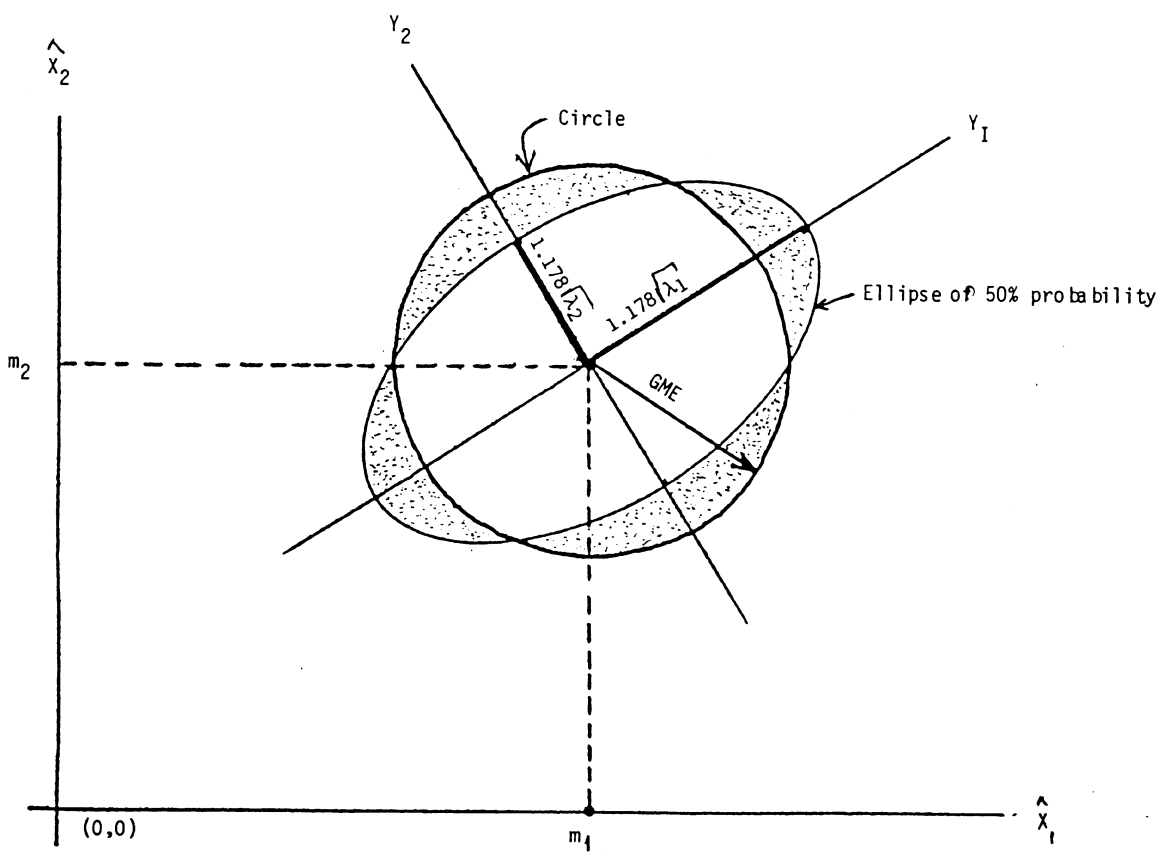

$$\left. \begin{aligned} \text{Area of the 50\% ellipse} &= \pi(1.178\sqrt{\lambda_1})(1.178\sqrt{\lambda_2}) \\ \text{Area of the GME circle} &= \pi(GME)^2 \end{aligned} \right\} \rightarrow GME = 1.178(\lambda_1\lambda_2)^{1/4}$$

Figure 3.12: The Definition of the Geometrical Mean Error (GME).

### 3.2.4 Circles Including a Specified Probability

An approximate formula for the radii ( $R_p$ ) of circles which include a specified probability of a Normal bivariate distribution is given by (Oberg, 1947):

$$R_p = (\sqrt{\lambda_1} + \sqrt{\lambda_2}) \sqrt{\left(\frac{1}{2}\right) \ln\left(\frac{1}{1-p}\right)} \quad (3.73)$$

Hence, if one wants to calculate the factor with which the value of CPE should be multiplied to obtain another circle with probability, say 75%, we have:

$$\frac{R_{75}}{R_{50}} = \frac{R_{75}}{\text{CPE}} = \frac{(\sqrt{\lambda_1} + \sqrt{\lambda_2}) \sqrt{\frac{1}{2} \ln\left(\frac{1}{1-0.75}\right)}}{(\sqrt{\lambda_1} + \sqrt{\lambda_2}) \sqrt{\frac{1}{2} \ln\left(\frac{1}{1-0.50}\right)}} \quad (3.74)$$

or

$$R_{75} = 1.414 \text{ CPE} \quad (3.75)$$

Table (3) (Burt et al., 1966) shows the relationship between CPE and various radii of other probability circles.

It should also be mentioned that the area of the CPE circle is always greater than the area of the error ellipse of equivalent probability (Burt et al., 1966). Moreover, the CPE value is simpler than an error ellipse since it does not require three quantities ( $\lambda_1, \lambda_2, \theta$ ) as the error ellipse does to be specified. Nevertheless, it has some disadvantages (Roeber, 1982):

Multiply Value of CPE by	To Obtain the Radius of Circle of Probability
2.578	99%
2.079	95%
1.823	90%
1.655	85%
1.524	80%
1.414	75%
1.318	70%
1.150	60%

**TABLE 3**

Relationship of CPE and radii of other probability  
circles

1. It ignores the nature of the distribution of errors. All possible fixes should lie within an ellipse rather than a circle when the observations are Normally distributed.
2. It provides no information on the direction of maximum error.
3. Nothing is known about the fixes outside the circle in terms of probability and magnitude.

Haggstrom (1979) has also considered the problem of devising a sequential test of the hypotheses:

$$H_1 : \hat{CPE} = CPE_1 \quad (3.76)$$

versus

$$H_2 : \hat{CPE} = CPE_2 \quad (3.77)$$

where  $CPE_1$  and  $CPE_2$  are predescribed constants with the condition

$$CPE_2 > CPE_1 \quad (3.78)$$

A great amount of investigation has been carried out on the issue of the Circular Probable Error and the reader is referred to the references for an extensive reading.

### 3.2.5 The drms Error

The drms (distance root-mean-square) is defined as the square root of the sum of the squares of the semi-major and semi-minor axes of the standard error ellipse (see Figure 3.13), that is:

$$d_{\text{rms}} = \sqrt{\sigma_1^2 + \sigma_2^2} = \sqrt{\lambda_1 + \lambda_2} \quad (3.79)$$

The quantity drms is a rather confusing error measure because it provides no information about the probability associated with each value of it (Burt et al., 1966).

It is noteworthy that the error figure  $2\text{drms}$ , described in the Federal Radionavigation Plan (USDoD, 1982) as the circle containing at least 95% of all possible fixes, is derived by multiplying CPE by 2.5.

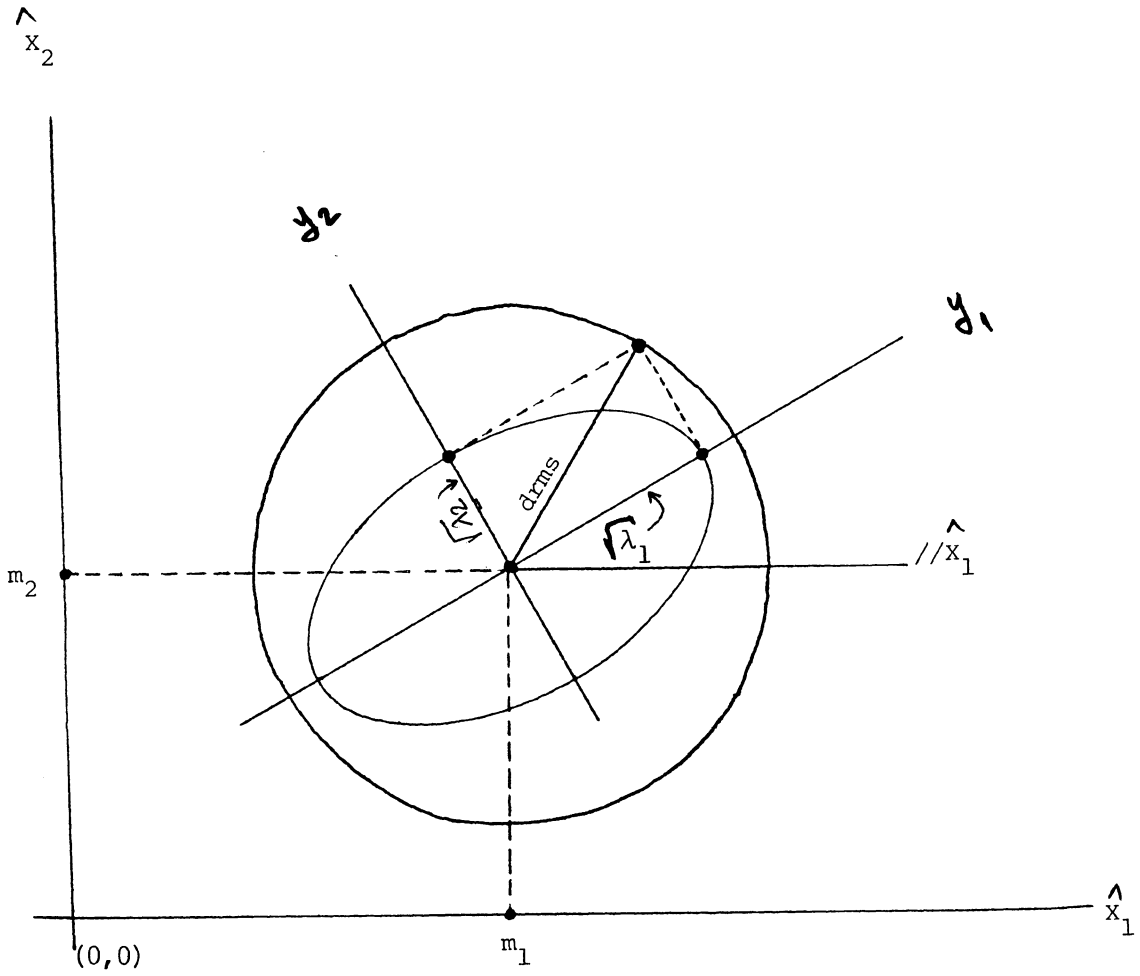

Figure 3.13: The drms Radial Error ( $\text{drms} = \sqrt{\sigma_1^2 + \sigma_2^2} = \sqrt{\lambda_1 + \lambda_2}$ )

### 3.3 ONE-DIMENSIONAL ACCURACY MEASURES

#### 3.3.1 The Standard Deviation

Another simplified approach to characterize uncertainty in navigation is to treat errors in each dimension separately and to introduce the notion of the standard deviation (1 sigma,  $\sigma$ ). The relationship between accuracy expressions and probability when the underlying distribution of errors is again Normal is shown in the following Table (4).

Accuracy Expression	Error Level	Probability (percent)
three sigma	$3\sigma$	99.7
two sigma	$2\sigma$	95.0
one sigma	$1\sigma$	68.0
Average error	$0.80\sigma$	58.0
Probable error	$0.67\sigma$	50.0

**TABLE 4**  
Normal Distribution of Errors

Other scalar accuracy expressions are: the root-sum-square error (RSS, or  $\epsilon_{RSS}$ ) the root-mean-square error (RMS, or  $\epsilon_{RMS}$ ) and the Geometric Dilution of Precision (GDOP).



### 3.3.2 The Root-Sum-Square Error

For a  $u$ -dimensional problem, the root-sum-square error is defined by:

$$\epsilon_{\text{RSS}} = \sqrt{E\left[\sum_{i=1}^u (\hat{x}_i - x_i)^2\right]} = \sqrt{\text{trace}(C) + \sum_{i=1}^u b_i^2} \quad (3.81)$$

or equivalently

$$\begin{aligned} \epsilon_{\text{RSS}} &= \sqrt{(\sigma_1^2 + \dots + \sigma_u^2) + \left(\sum_{i=1}^u b_i^2\right)} = \\ &= \sqrt{(\lambda_1 + \lambda_2 + \dots + \lambda_u) + \left(\sum_{i=1}^u b_i^2\right)} \end{aligned} \quad (3.82)$$

If the estimator is unbiased then  $E[\hat{x}_i] = x_i$ , for  $i=1, u$  the root-sum-square error becomes:

$$\epsilon_{\text{RSS}} = \sqrt{\sigma_1^2 + \sigma_2^2 + \dots + \sigma_u^2} = \sqrt{\lambda_1 + \lambda_2 + \dots + \lambda_u} \quad (3.83)$$

### 3.3.3 The Root-Mean-Square Error

The root-mean-square error is defined by:

$$\epsilon_{\text{RMS}} = \text{RMS} = \sqrt{\frac{\sigma_1^2 + \dots + \sigma_u^2}{u}} = \sqrt{\frac{\lambda_1 + \dots + \lambda_u}{u}} \quad (3.84)$$

It is noteworthy that the word "mean" indicates division by the number of involved parameters, that is  $u$ .

### 3.3.4 The Geometric Dilution of Precision

Geometric Dilution of Precision (GDOP) is a quantity (factor) used in determining the information content due to geometry in a position fix. It provides a method to decide whether a particular geometry of reference stations (e.g., satellites) is good or bad. The GDOP is defined as the ratio of root-sum-square position error to the root-mean-square ranging error, that is:

$$\text{GDOP} = \frac{\epsilon_{\text{rss}}(\text{position})}{\epsilon_{\text{rms}}(\text{range})} = \frac{\sqrt{\text{trace}(\mathbf{C})}}{\sqrt{\frac{\sigma_{1,r}^2 + \dots + \sigma_{N,r}^2}{N}}} \quad (3.85)$$

where  $\text{trace}(\mathbf{C}) = \sigma_1^2 + \dots + \sigma_u^2 = \lambda_1 + \lambda_2 + \dots + \lambda_u$  and the standard deviations  $\sigma_{1,r}, \sigma_{2,r}, \dots, \sigma_{N,r}$  are the errors in the  $N$  ranges with which a position  $\hat{\mathbf{x}} = (\hat{x}_1, \hat{x}_2, \dots, \hat{x}_u)$  was obtained. For a detailed account of the Dilution of Precision measures the reader is referred to Lee(1975a,b), Mertikas(1983) and Torrieri(1984).

#### 4. CONCLUSIONS AND FUTURE TRENDS

There are a number of variables in nature, such as navigation errors, which can be represented as random variables. To quantify aspects of the behaviour of this kind of complex phenomena is not an easy task. One usually constructs a mathematical model of the situation and studies the properties of the model in order to obtain some insight into the behaviour of the "real" situation being modelled.

In this paper, we have gone through different error distributions and accuracy measures in current navigational use, and as we already mentioned all the preceding statistical analysis considers static random variation. This kind of variation does not depend on space (position) or time. In reality, navigational errors seem to behave in a different way. For example, LORAN-C phaselag errors introduce:

1. Distortions in a pattern varying in space and to a lesser degree
2. temporal variations (mainly seasonal) which also vary in space.

Another example is in satellite navigation. There, navigation errors can again be formulated as variations in time, because of temporal changes in satellite-user geometry, in atmospheric conditions, etc., and as variations of user's position,  $(x_1, x_2, x_3) = (\phi, \lambda, h)$ , for similar reasoning. Therefore, a more dynamic approach appropriate to a science of

motion would be the consideration of navigation errors as a function of space  $\underline{r}\{x_1, x_2, x_3\} = \underline{r}\{\phi, \lambda, h\}$  and time  $\{t\}$ , that is:

$$x\{\underline{r}, t\} = x\{x_1, x_2, x_3, t\} = x\{\phi, \lambda, h, t\} \quad (4.1)$$

Since errors in navigation may be seen as varying randomly in time and in space, research has been initiated at the University of New Brunswick (Mertikas, 1984) to suggest a common language appropriate to a study of position errors through the theory of random fields (Preston, 1976; Adler, 1980; Kallianpur, 1983; Vanmarcke, 1983). A random field constitutes a generalization of the concept of a stochastic process (Wong, 1971) which deals with probabilistic variation as a function of a single parameter usually time. This is the theory which seeks to model complex patterns of variation where deterministic treatment is inefficient and conventional statistics inadequate. It is a process which is characterized by active and inherent uncertainty: properties at different points in space change randomly with time. A geometrical depiction of a random field is shown in Figure (4.1).

Another issue that has to be regarded for future research is the examination of error models. The proper selection of error models will certainly favour the reliable interpretation of the derived accuracy measures. Unfortunately, if one

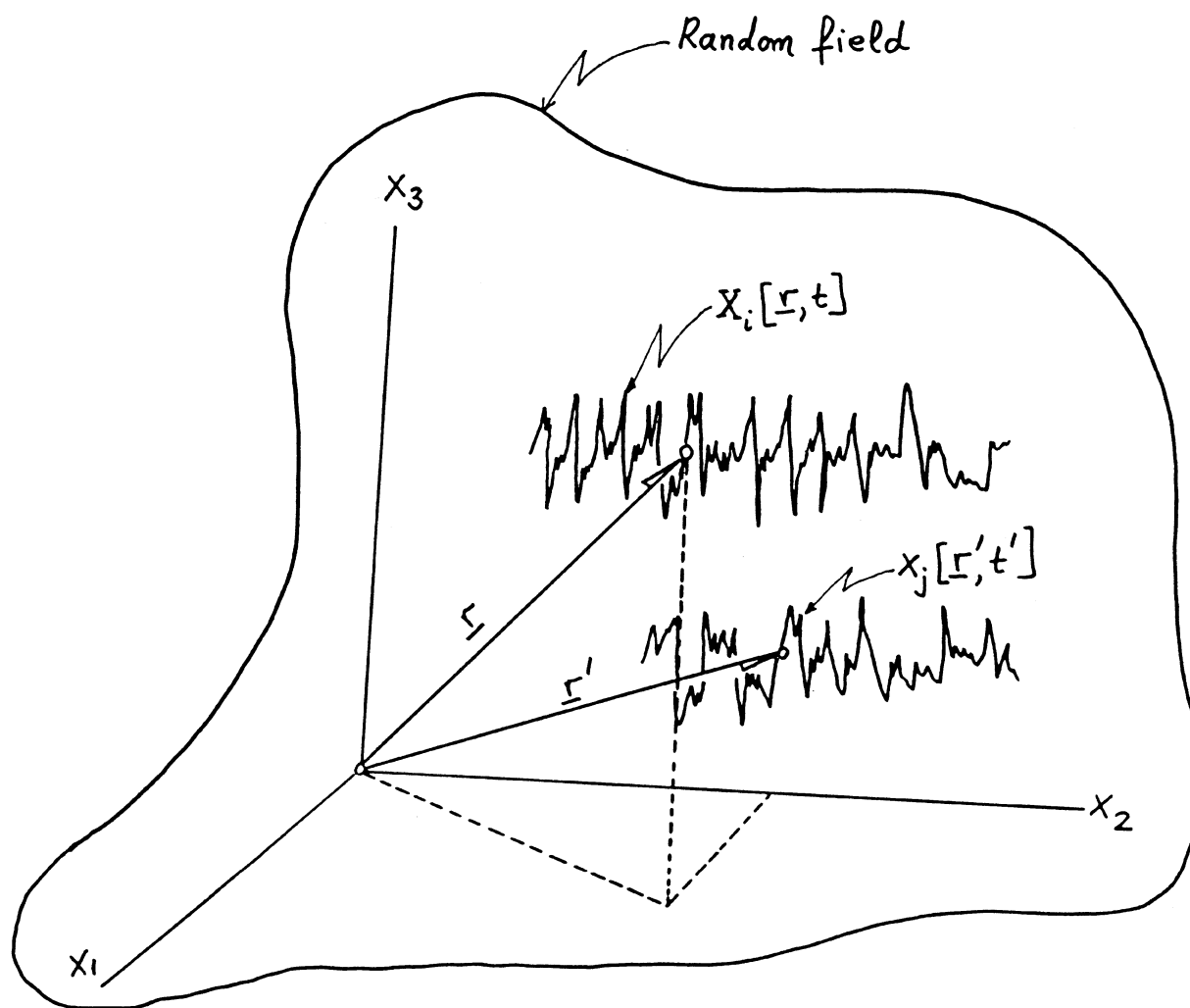

Figure 4.1: The Geometry of a Random Field.

does not know the form of the distribution he may not have a good idea of the accuracy of the system under consideration. For example, if the accuracy of a navigation system is expressed in terms of a standard deviation, and if the distribution is Normal, it will be accurate two times out of three (67% probability). Whereas, if it is exponential it will be accurate three times out of four (75% probability). Could Robust techniques (Huber,1972), which are insensitive to deviations from Normality, or non-parametric statistics (Fraser,1957; Daniel,1978), where the probability function is unknown, also help in this vein? Subsequently, new research areas have been opened and, as Wing Commander E.W. Anderson mentioned "some expert will be prepared to open his mind and not flinch from the danger of putting his foot in it'.

## REFERENCES

- Abbott, M.R. (1965). "Some Remarks on the Distribution of Aircraft Track-keeping Errors". The Journal of Navigation (UK), Vol.18, pp. 312-318.
- Adler, R. (1981). "The geometry of random fields". Wiley, New York.
- Anderson, E.W. (1965). "Is the Gaussian Distribution Normal". The Journal of Navigation (UK), Vol.18, pp.65-69.
- Anderson, E.W. and D.M. Ellis (1971). "Error Distributions in Navigation" The Journal of Navigation (UK), Vol.22, No.4, pp.429-442.
- Anderson, O.D. (1976). "On Error Distributions in Navigation". The Journal of Navigation (UK), Vol.29, pp.69-75.
- Anderson, O.D. (1976). "Error Distribution in Navigation". Journal of Navigation (UK), FORUM, Vol.29, pp.298-301.
- Anderson, O.D. (1977). "On the Cost of Making Mistakes in Navigation". Navigation: Journal of Inst. of Navigation, Vol.24, No.2, pp.166-167.
- Bell, Jeffrey W. (1972). "A Note on CEPs". IEEE Transactions on Aerospace and Electronic Systems, Correspondence, pp.111-112, January.
- Bendat, J.S. and A.G. Piersol (1971). "Random Data: Analysis and Measurement Procedures". Wiley-Interscience, New York.
- Burgerhout, T.J. (1973). "A Class of Probability With Applications to Aircraft Flight Path Analysis". Technometrics, Vol.15, No.2, pp. 365-378
- Burt, A.W., D.J. Kaplan, R.R. Keenly, J.F. Reeves, and F.B. Shaffer (1966). "Mathematical considerations pertaining to the accuracy of position location and navigation systems-part I". Stanford Research Institute, Menlo, California, Research Memorandum NWRC-RM34, NTIS# AD 629-609.
- Butterly, Peter, J. (1972). "Position Finding with Empirical Prior Knowledge", IEEE Trans. on Aerospace and Electronic Systems, Vol. AES-8, No.2, pp.142-146, March.

- Childs D.R., D.M. Coffey and S.P. Travis (1978). "Error Measures for Normal Random Variables". IEEE Transactions on Aerospace and Electronic Systems, Vol. AES-14, No. 1, pp. 64-67, January.
- Cooper, D.C. and P.J. Laite (1969). "Statistical Analysis of Position Fixing in Three Dimensions", Proc. The Institution of Electrical Engineers, Vol. 116, No. 9, pp. 1505-1507, September.
- Cooper, D.C. (1972). "Statistical Analysis of Position-Fixing General Theory for Systems With Gaussian Errors", Proc. The Institution of Electrical Engineers, Vol. 119, No. 6, pp. 637-640, June.
- Crossley, A.F. (1966). "On the Frequency Distribution of Large Errors". The Journal of Navigation (UK), Vol. 19, pp. 33-40.
- Daniel, W.W. (1978). "Applied non-parametric Statistics". Houghton Mifflin Company, Boston.
- Edmundson, H.P. (1961). "The Distribution of Radial Error and its Statistical Application in War Gaming". Operations Research, Vol. 9, pp. 8-22.
- Feller, William (1968). "An Introduction to Probability Theory and its Applications", Volume I and II, John Wiley & Sons, Inc., New York.
- Fraser, D.A.S. (1957). "Non-parametric Methods in Statistics". Wiley, New York.
- Gilliland, D.C. (1962). "Integral of the Bivariate Normal Distribution Over an Offset Circle" Journal of the American Statistical Association, Vol. 57, pp. 758-768.
- Grad, A. and H. Solomon (1955). "Distributions of Quadratic Forms and Some Applications". Annals of Math. Stat., Vol. 26, pp. 464-477.
- Grubbs, Frank E. (1964). "Approximate Circular and Noncircular Offset Probabilities of Hitting", Operations Research, Vol. 12, No. 1, pp. 51-62.
- Haggstrom, G.W. (1979). "Sequential Tests for Circular Probable Errors" The Rand Corporation, Santa Monica, California, P-6345, May.
- Harter, L.H. (1960). "Circular Error Probabilities". Amer. Stat. Assn., Vol. 55, pp. 723-731.



- Hill, B.M. (1975). "A Simple General Approach to Inference About the Tail of a Distribution". Annals of Math. Stat., Vol.3, No.5, pp.1163-1174.
- Hiraiwa, T. (1967). "On the 95 per cent Probability Circle of a Vessel's Position-I". The Journal of Navigation (UK), Vol.20, pp. 258.
- Hiraiwa, T. (1978). "The Distribution Pattern of Omega Observations". The Journal of Navigation (UK), Vol.31, No.2, pp.306-309.
- Hiraiwa, T. (1980). "On the 95 per cent Probability Circle of a Vessel's Position-II". The Journal of Navigation (UK), Vol.33, No.1, pp.223-226.
- Hsu, D.A. (1979a). "An Analysis of Error Distributions in Navigation". (with comments by E.W.Anderson), The Journal of Navigation (UK), Vol.32, pp.426.
- Hsu, D.A. (1979b). "Long-tailed Distributions for Position Errors in Navigation". Journal of the Royal Statistical Society, Series C (Applied Statistics), Vol.28, No.1, pp.62-72.
- Hsu, D.A. (1980). "Further Analysis of Position Errors in Navigation". The Journal of Navigation (UK), Vol.33, No.3, pp.452-474
- Hsu, D.A. (1981). "The Evaluation of Aircraft Collision Probabilities in Intersecting Air Routes". The Journal of Navigation (UK), Vol.34, No.1, pp.78-102.
- Hsu, D.A. (1983). "A Theoretical Framework for Analysis of Lateral Position Errors in VOR Jet-Route Systems". The Journal of Navigation (UK), Vol.36 No.2, pp.262-268.
- Huber, P.J (1972). "Robust Statistics: A Review". The Annals of Math. Stat., Vol.43, No.4, pp.1041-1067.
- Inselmann, Edmund, H. and W.Granville, Jr. (1967). "Circular Distribution Estimation", Operations Research, Vol.15, No.1, pp.160-165.
- Isley, C.T. (1980). "A Procedure for Directly Calculating CEP in DF Fixing". IEEE Transactions on Aerospace and Electronic Systems, Correspondence, Vol.AES-16, No.6, pp.867-870.
- Johnson, R.A. and D.W.Wichern (1982). "Applied Multivariate Statistical Analysis". Prentice-Hall, Inc., Englewood Cliffs, New Jersey.

- Johnson, N.L. and S.Kotz(1970). Distributions in Statistics: Vol.I:Discrete Distributions, Vol.II:Continuous Distributions-I, Vol.III:Continuous Distributions-II , Houghton Mifflin Company, Boston.
- Johnson, R.S.; S.D.Cottrill; P.Z.Peebles(1969). "A Computation of Radar SEP and CEP". IEEE Transactions on Aerospace and Electronic Systems, Correspondence, pp.353-354, March.
- Kallianpur, G. (ed)(1983). "Theory and Applications of Random Fields", Springer-Verlag, New York.
- Kendall, M.G. and W.R.Buckland(1982). A Dictionary of Statistical Terms, Longman Group Ltd., London and New York, Fourth edition.
- Kuebler, W and S.Sommers(1982). "A Critical Review of the Fix Accuracy and Reliability of Electronic Marine Navigation Systems" Navigation: The Journal of the Institute of Navigation, Vol.29, No.2, pp.137-151, Summer.
- Laurent, Andre G. (1957). "Bombing Problems-A Statistical Approach" Operations Research, Vol.5, pp.75-89.
- Lee, Harry, B. (1975a). "A Novel Procedure for Assessing the Accuracy of Hyperbolic Multilateration Systems", IEEE Trans. Aerospace and Electronic Systems, Vol.AES-11, No.1, pp.2-15, January.
- Lee, Harry, B. (1975b). "Accuracy Limitations of Hyperbolic Multilateration Systems", IEEE Trans. Aerospace and Electronic Systems, Vol.AES-11, No.1, pp.16-29, January.
- Livingstone, D.B. and R.K.H.Falconer(1980). "Skywave LORAN-C Navigation at Sea in the Canadian Arctic". Proceedings of the 19th Annual Canadian Hydrographic Conference, Halifax N.S., pp.38-42, March.
- Lloyd, D.A. (1966). "A Probability Distribution for a Time-varying Quantity". The Journal of Navigation (UK), Vol.19, pp.119-122.
- Lord, R.N. and D.A.Overton(1971). "Synthesis of the Aircraft Navigational Across-Track Error", Cranfield Institute of Technology, Cranfield Report E&C No.2, March.
- Lord, R.N. (1973). "Error Synthesis". The Journal of Navigation (UK), Vol.26, No.3, pp.329-340.
- Marchand, Nathan (1964). "Error Distributions of Best Estimate of Position from Multiple Time Difference Hyperbolic Networks" IEEE Trans. on Aerospace and Navigational Electronics, Vol.ANE-11, No.2, pp.96-100, June.

- Mertikas, S.P. (1983). "Differential Global Positioning System Navigation: A Geometrical Analysis", Technical Report #95, Surveying Engineering, The University of New Brunswick, Fredericton, N.B., May.
- Mertikas, S.P. (1984). "Analysis and Interpretation of Navigation Errors Through the Theory of Random Fields", Ph.D. Proposal (Internal Report) Surveying Engineering, The University of New Brunswick, Fredericton, N.B., April.
- Moon Warren D. (1964). "Measurement Accuracy". IEEE Transactions on Aerospace, Vol. AS-2, pp.1161-65, October.
- Moranda, P.B. (1960a). "Comparison of Estimates Of CEP". J. Amer. Stat. Assn., Vol. 54, pp.794.
- Moranda, P.B. (1960b). "Effects of Bias on Estimates of the CEP". J. Amer. Stat. Assn., Vol. 55, pp.732.
- Nicholson, David L. (1974). "Analytical Derivation of an Accurate Approximation of CEP for Elliptical Error Distributions". IEEE Transactions on Vehicular Technology, Vol. VT-23, No.1, pp.16-19, February.
- Oberg, E.N. (1947). "Approximate Formulas for the Radii of Circles Which Include a Specified Fraction of a Normal Bivariate Distribution". Annals of Math. Stat., Vol. 18, pp.442-447.
- Olsen, Dale E. (1977). "A Note on the Relationship Between Correlation and Circular Error Probability (CEP)". Naval Research Logistics Quarterly, Vol. 24, No. 3, pp.511-516, September.
- Parker, J.B. (1966). "The Exponential Integral Frequency Distribution". The Journal of Navigation (UK), Vol. 19, pp.526-528.
- Parker, J.B. (1972). "Error Distributions in Navigation". The Journal of Navigation, FORUM, Vol. 25, No. 2, pp.250-252.
- Parker, J.B. (1981). "Probability Models for Navigational Data". The Journal of Navigation (UK), FORUM, Vol. 34, No. 3, pp.470, September
- Preston, Cris (1976). "Random Fields", Springer-Verlag, New York
- Rabone, N.S. (1971). "A Universal Program for Computing the Aircraft Navigation Error", Thesis submitted to the Department of Electronic and Control Engineering, Cranfield Institute of Technology, Cranfield Bedford, England, September.

- Reich, P.G. (1966). "Analysis of Long-Range Air Traffic Systems: Separation Standards I, II, III". The Journal of Navigation (UK), Vol.19, pp.88-98(I), pp.169-186(II), pp.331-347(III).
- Roeber, J.F. (1982). "Accuracy What is it?, Why Do I Need it?, How Much Do I Need?". Proceedings of the National Marine Meeting (ION) Cambridge, Mass. October 27-29.
- Romanowski, M. (1979). "Random Errors in Observations and the Influence of Modulation on their Distribution". Verlag Konrod Wittuer, Stuttgart.
- Rosenblatt, Joan, R. (1978). "Statistical Models for Random Errors of Position Location Based on Lines of Position", National Bureau of Standards, Interagency Report, May, NTIS# PB281158/6GA.
- Ruber, H. (1960). "Probability Content of Regions Under Spherical Normal Distribution". Annals of Math. Stat., Vol.31, pp.598.
- Scheuer, E.M. (1962). "Moments of the Radial Error". J. Amer. Stat. Assn., Vol.57, pp.187.
- Slagle, D.C. and R.J.Wenzel (1982). "LORAN-C Signal Stability Study. St. Lawrence Seaway". Report No.CG-D-39-82, NTIS# ADA 122 476.
- Staras, H. and R.W.Klopfenstein (1960). "A Statistical Analysis of Cross-Track Errors in a Navigation System Utilizing Intermittent Fixes". IRE Transactions on Aeronautical and Navigational Electronics, pp.15-19, March.
- Terzian, R.C. (1974). "Discussion of 'A Note on CEP's". IEEE Transactions on Aerospace and Electronic Systems, Correspondence, pp.717-718, January.
- Torrieri, Don, J. (1984). "Statistical Theory of Passive Location Systems" IEEE Trans. on Aerospace and Electronic Systems, Vol.AES-20, No.2, pp.183-198, March.
- Tukey, J.W. (1960). "A Survey of Sampling Form Contaminated Distributions", In: Contributions to Probability and Statistics (ed.Olkin), pp.448-485, Stanford, Stanford University Press.
- U.S. Department of Defense (1982). "Federal Radionavigation Plan", Vols.I, II, III, IV, March.
- Vanicek and Krakiwsky (1982). "Geodesy: The Concepts", North-Holland, Amsterdam

- Vanmarcke, E. (1983). "Random Fields: Analysis and Synthesis". The MIT press, Cambridge, Mass.
- Weil, Herschel (1954). "The Distribution of Radial Error" Annals of Mathematical Statistics, Vol.25, pp.168-170.
- Weingarten, Harry and A.R. Didonato (1961). "A Table of Generalized Circular Error". Mathematics of Computation, Vol.15, pp.169.
- Wong, Eugene (1971). "Stochastic Processes in Information and Dynamical Systems". McGraw-Hill Book Company, New York.
- Zacks, S. and H. Solomon (1975). "Lower Confidence Limits for the Impact Probability Within a Circle in the Normal Case" Naval Research Logistics Quarterly, Vol.22, No.1, pp.19-30, March.

Stelios P. Mertikas